

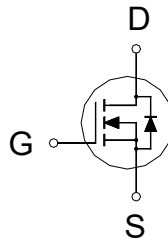

N-Channel Logic Level Enhancement Mode Field Effect Transistor

Product Summary:

| | |
|----------------------------|-------|
| BV _{DSS} | 40V |
| R _{DS(on)} (Typ.) | 2.9mΩ |
| I _D | 58A |



UIS, R_g 100% Tested

Pb-Free Lead Plating & Halogen Free



ABSOLUTE MAXIMUM RATINGS (T_C = 25 °C Unless Otherwise Noted)

| PARAMETERS/TEST CONDITIONS | | SYMBOL | LIMITS | UNIT |
|--|-------------------------|-----------------------------------|------------|------|
| Gate-Source Voltage | | V _{GS} | ±20 | V |
| Continuous Drain Current | T _C = 25 °C | I _D | 58 | A |
| | T _A = 25 °C | | 20 | |
| | T _C = 100 °C | | 36 | |
| Pulsed Drain Current ¹ | | I _{DM} | 93 | |
| Avalanche Current | | I _{AS} | 54 | |
| Avalanche Energy | L = 0.1mH | E _{AS} | 143 | mJ |
| Repetitive Avalanche Energy ² | L = 0.05mH | E _{AR} | 71 | |
| Power Dissipation | T _C = 25 °C | P _D | 20 | W |
| | T _C = 100 °C | | 8.3 | |
| Power Dissipation | T _A = 25 °C | P _D | 2.5 | W |
| | T _A = 100 °C | | 1.0 | |
| Operating Junction & Storage Temperature Range | | T _J , T _{stg} | -55 to 150 | °C |

THERMAL RESISTANCE RATINGS

| THERMAL RESISTANCE | SYMBOL | TYPICAL | MAXIMUM | UNIT |
|----------------------------------|------------------|---------|---------|--------|
| Junction-to-Case | R _{θJC} | | 6 | °C / W |
| Junction-to-Ambient ³ | R _{θJA} | | 50 | |

¹Pulse width limited by maximum junction temperature.

²Duty cycle ≤ 1%

³50°C / W when mounted on a 1 in² pad of 2 oz copper.



ELECTRICAL CHARACTERISTICS (T_J = 25 °C, Unless Otherwise Noted)

| PARAMETER | SYMBOL | TEST CONDITIONS | LIMITS | | | UNIT |
|---|----------------------|--|--------|------|------|------|
| | | | MIN | TYP | MAX | |
| STATIC | | | | | | |
| Drain-Source Breakdown Voltage | V _{(BR)DSS} | V _{GS} = 0V, I _D = 250μA | 40 | | | V |
| Gate Threshold Voltage | V _{GS(th)} | V _{DS} = V _{GS} , I _D = 250μA | 1.0 | 1.7 | 2.4 | |
| Gate-Body Leakage | I _{GSS} | V _{DS} = 0V, V _{GS} = ±20V | | | ±400 | nA |
| Zero Gate Voltage Drain Current | I _{DSS} | V _{DS} = 32V, V _{GS} = 0V | | | 1 | μA |
| | | V _{DS} = 30V, V _{GS} = 0V, T _J = 125 °C | | | 25 | |
| On-State Drain Current ¹ | I _{D(ON)} | V _{DS} = 10V, V _{GS} = 10V | 58 | | | A |
| Drain-Source On-State Resistance ¹ | R _{DS(ON)} | V _{GS} = 10V, I _D = 20A | | 2.9 | 3.6 | mΩ |
| | | V _{GS} = 4.5V, I _D = 15A | | 3.6 | 4.8 | |
| Forward Transconductance ¹ | g _{fs} | V _{DS} = 5V, I _D = 20A | | 50 | | S |
| DYNAMIC | | | | | | |
| Input Capacitance | C _{iss} | V _{GS} = 0V, V _{DS} = 20V, f = 1MHz | | 2805 | | pF |
| Output Capacitance | C _{oss} | | | 566 | | |
| Reverse Transfer Capacitance | C _{rss} | | | 64 | | |
| Gate Resistance | R _g | V _{GS} = 15mV, V _{DS} = 0V, f = 1MHz | | 1.5 | | Ω |
| Total Gate Charge ^{1,2} | Q _g | V _{DS} = 20V, V _{GS} = 10V, I _D = 20A | | 45.8 | | nC |
| Gate-Source Charge ^{1,2} | Q _{gs} | | | 7.6 | | |
| Gate-Drain Charge ^{1,2} | Q _{gd} | | | 8.9 | | |
| Turn-On Delay Time ^{1,2} | t _{d(on)} | V _{DS} = 20V, I _D = 20A, V _{GS} = 10V, R _G = 6Ω | | 15 | | nS |
| Rise Time ^{1,2} | t _r | | | 10 | | |
| Turn-Off Delay Time ^{1,2} | t _{d(off)} | | | 40 | | |
| Fall Time ^{1,2} | t _f | | | 15 | | |
| SOURCE-DRAIN DIODE RATINGS AND CHARACTERISTICS (T_C = 25 °C) | | | | | | |
| Continuous Current | I _S | | | | 58 | A |
| Pulsed Current ³ | I _{SM} | | | | 93 | |
| Forward Voltage ¹ | V _{SD} | I _F = 20A, V _{GS} = 0V | | | 1.2 | V |
| Reverse Recovery Time | t _{rr} | I _F = 20A, dI _F /dt = 100A / μS | | 40 | | nS |
| Reverse Recovery Charge | Q _{rr} | | | | 64 | |

¹Pulse test : Pulse Width ≤ 300 μsec, Duty Cycle ≤ 2%.

²Independent of operating temperature.

³Pulse width limited by maximum junction temperature.

EMC will review datasheet by quarter, and update new version.



TYPICAL CHARACTERISTICS

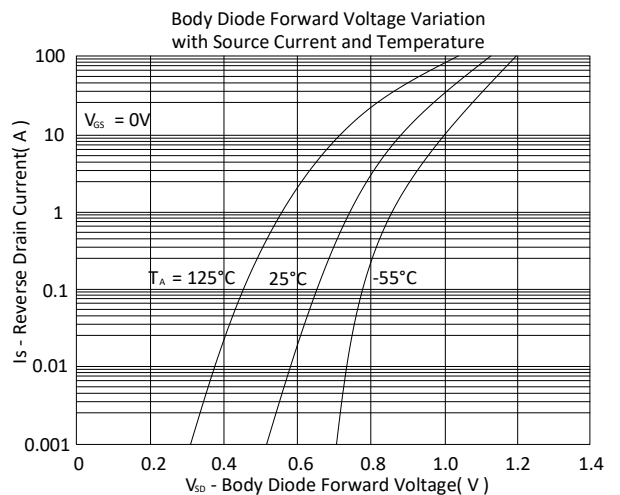
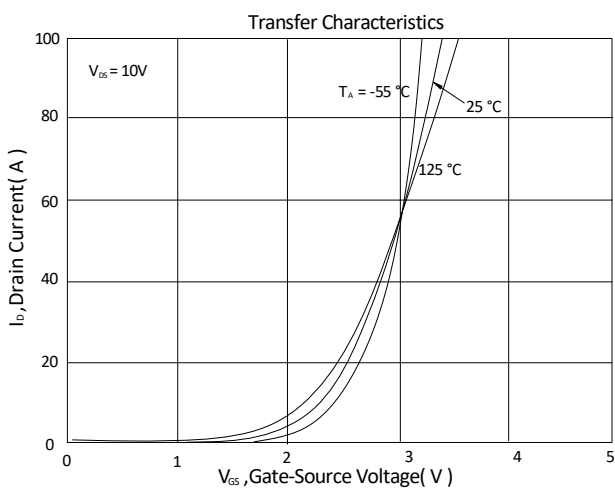
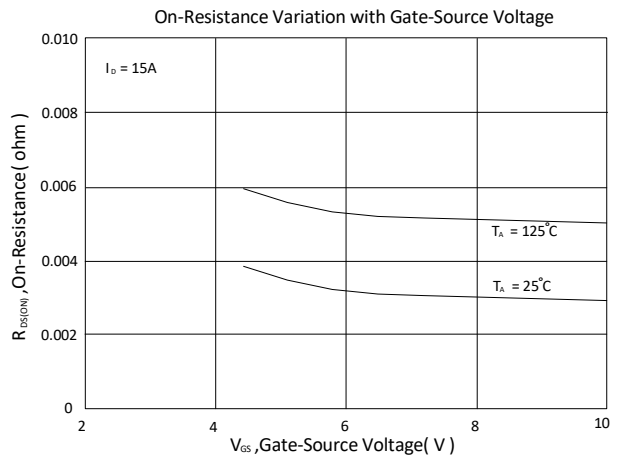
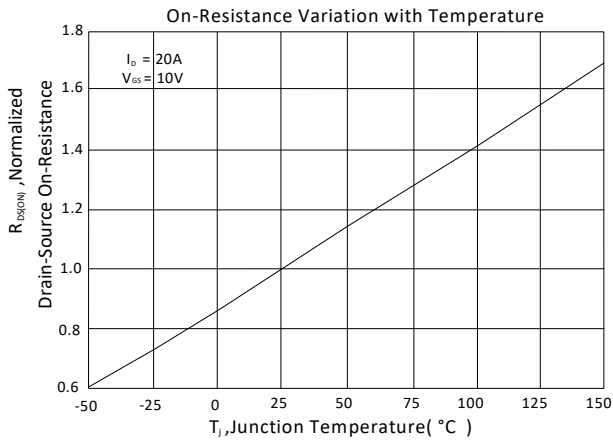
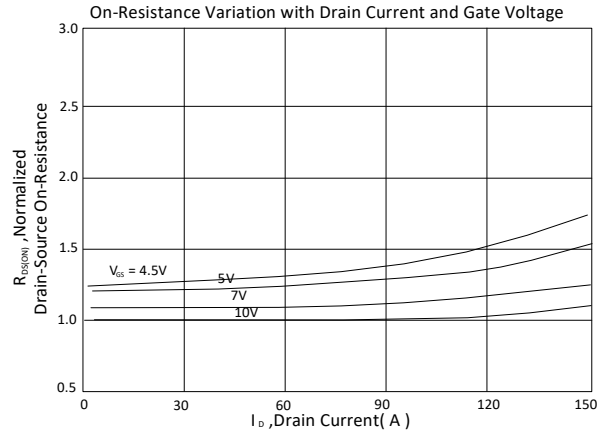
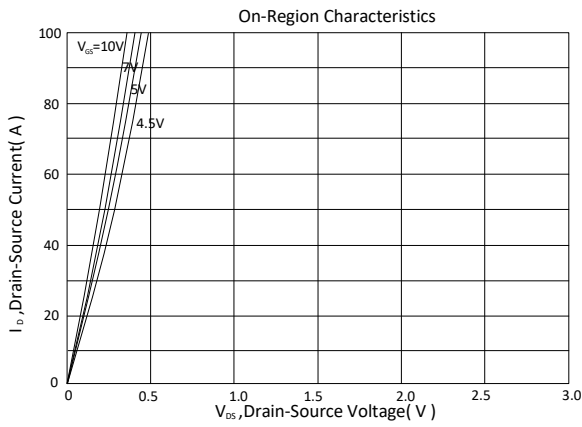

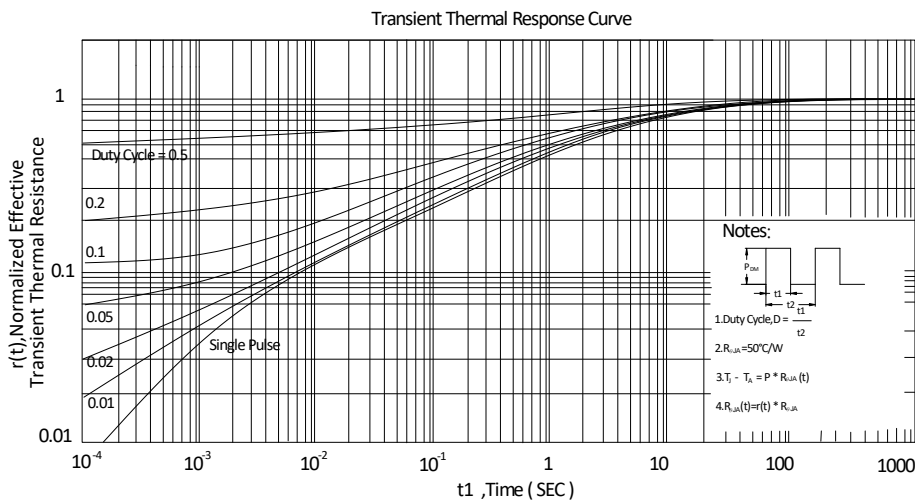
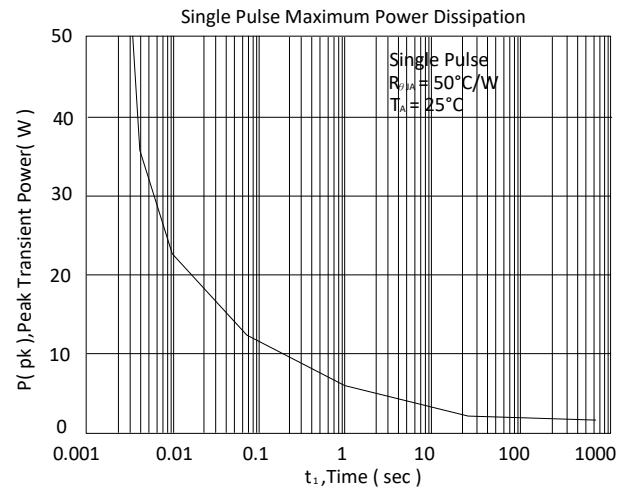
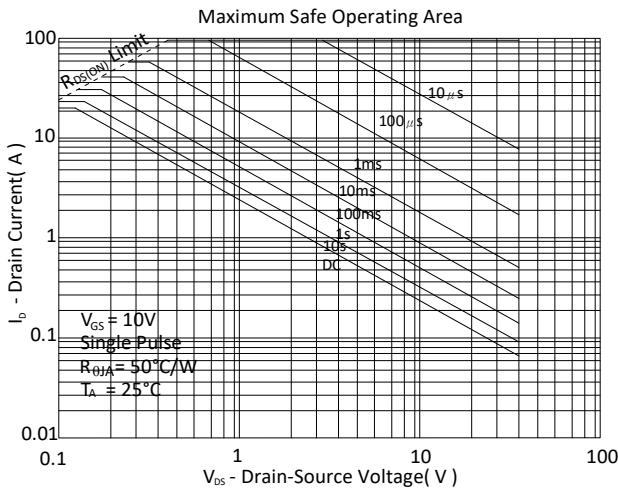
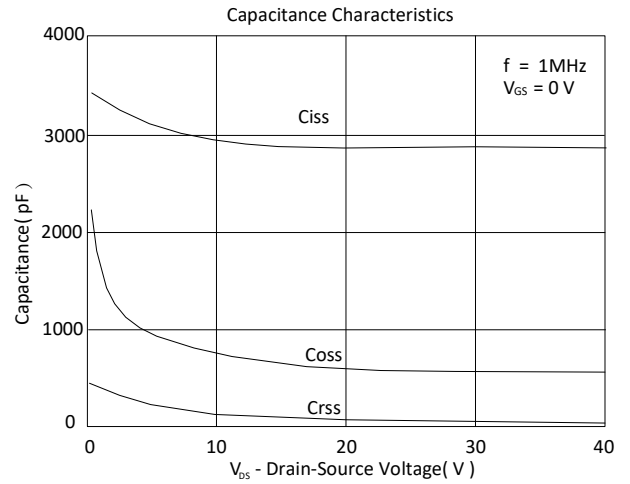
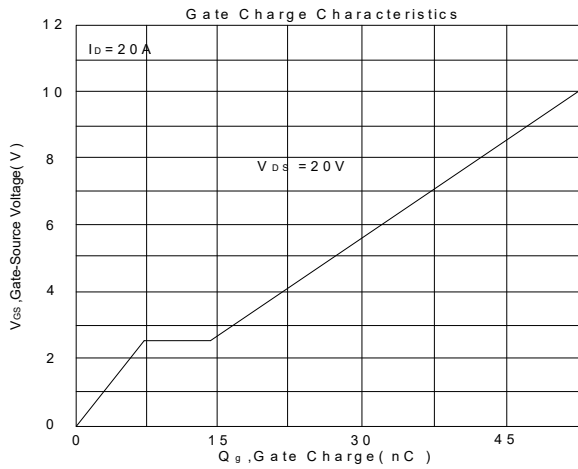

Ordering & Marking Information:

Device Name: EMP29N04VS for EDFN3X3



→ P29N04S : Device Name

→ ABCDEFG: Date Code

A: Assembly House

B: Year(A:2008 B:2009 C:2010....)

C: Month(A:01 B:02 C:03 D:04 E:05 F:06 G:07 H:08 I:09 J:10 K:11 L:12)

DEFG: Serial No.

Outline Drawing

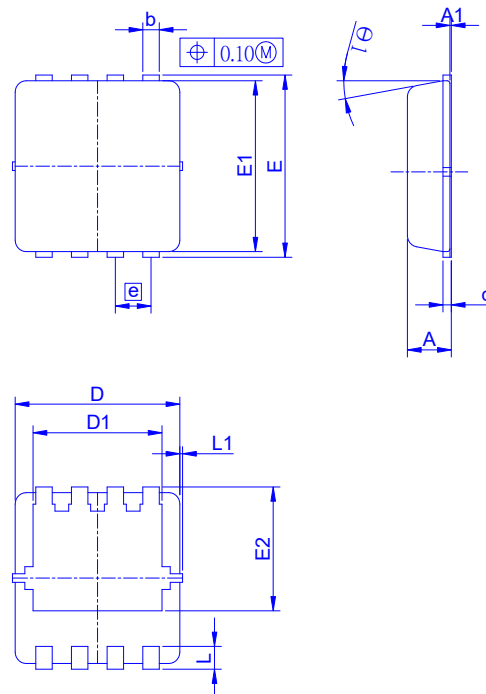

Dimension in mm

| Dimension | A | A1 | b | c | D | D1 | E | E1 | E2 | e | L | L1 | θ |
|-----------|------|------|------|------|------|------|------|------|------|------|------|-------|----------|
| Min. | 0.65 | 0 | 0.20 | 0.10 | 2.90 | 2.15 | 3.10 | 2.90 | 1.53 | 0.55 | 0.25 | - | 0° |
| Typ. | 0.75 | - | 0.30 | 0.15 | 3.00 | 2.45 | 3.20 | 3.00 | 1.97 | 0.65 | 0.40 | 0.075 | 10° |
| Max. | 0.90 | 0.05 | 0.40 | 0.25 | 3.30 | 2.74 | 3.50 | 3.30 | 2.59 | 0.75 | 0.60 | 0.150 | 14° |

Recommended minimum pads

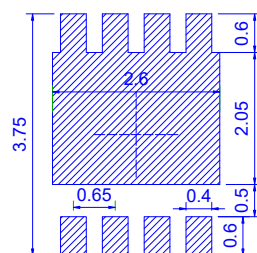



Tape&Reel Information: 5000pcs/Reel

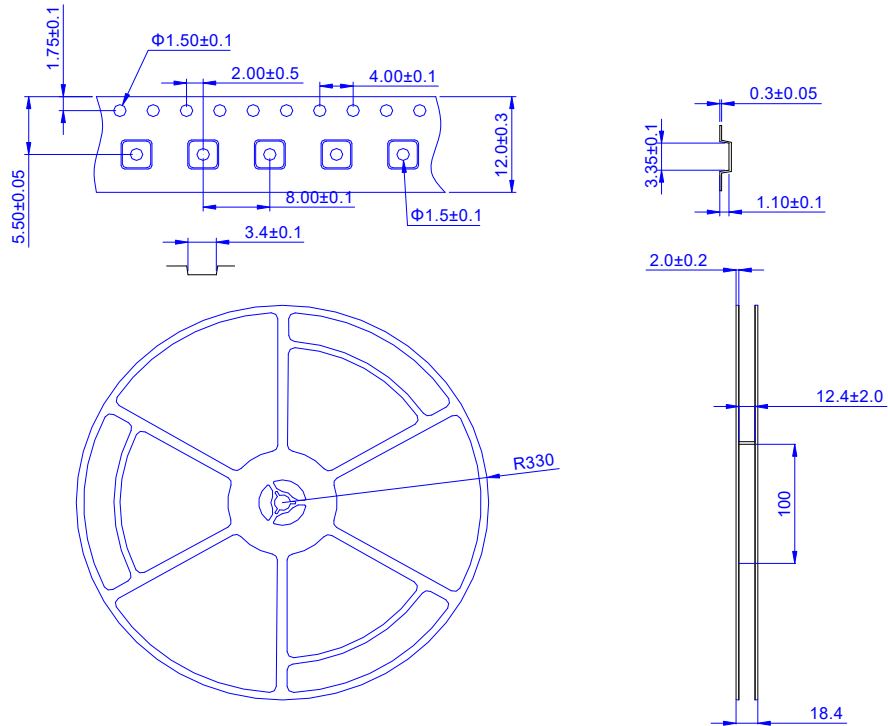

| | |
|---------|------------------------|
| 產品別 | EDFN3X3 |
| Reel 尺寸 | 13" |
| 編帶方式 | <p>FEEED DIRECTION</p> |
| 前空格 | 50 |
| 後空格 | 50 |
| 裝箱數 | |
| 滿捲數量 | 5K |
| 捲/內盒比 | 1 : 1 |
| 內盒滿箱數 | 5K |
| 內/外箱比 | 10 : 1 |
| 外箱滿箱數 | 50K |