

P-Channel Logic Level Enhancement Mode Field Effect Transistor

Product Summary:

BV _{DSS}	-20V
R _{DSON} (MAX.)	100mΩ
I _D	-3.4A

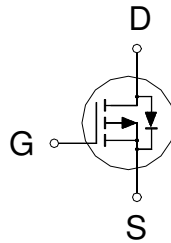

Pb-Free Lead Plating & Halogen Free



ABSOLUTE MAXIMUM RATINGS (T_A = 25 °C Unless Otherwise Noted)

PARAMETERS/TEST CONDITIONS		SYMBOL	LIMITS	UNIT
Gate-Source Voltage		V _{GS}	±12	V
Continuous Drain Current	T _A = 25 °C	I _D	-3.4	A
	T _A = 70 °C		-2.4	
Pulsed Drain Current ¹		I _{DM}	-14	
Power Dissipation	T _A = 25 °C	P _D	1.04	W
	T _A = 70 °C		0.66	
Operating Junction & Storage Temperature Range		T _J , T _{stg}	-55 to 150	°C

THERMAL RESISTANCE RATINGS

THERMAL RESISTANCE	SYMBOL	TYPICAL	MAXIMUM	UNIT
Junction-to-Ambient ³	R _{θJA} (T ≤ 10sec)		83	°C / W
	R _{θJA} (Steady State)		120	

¹Pulse width limited by maximum junction temperature.

²Duty cycle ≤ 1%

³The device mounted on a 1 in² pad of 2 oz copper.

ELECTRICAL CHARACTERISTICS ($T_J = 25\text{ }^\circ\text{C}$, Unless Otherwise Noted)

PARAMETER	SYMBOL	TEST CONDITIONS	LIMITS			UNIT
			MIN	TYP	MAX	
STATIC						
Drain-Source Breakdown Voltage	$V_{(BR)DSS}$	$V_{GS} = 0V, I_D = -250\mu A$	-20			V
Gate Threshold Voltage	$V_{GS(th)}$	$V_{DS} = V_{GS}, I_D = -250\mu A$	-0.3	-0.75	-1.2	
Gate-Body Leakage	I_{GSS}	$V_{DS} = 0V, V_{GS} = \pm 12V$			± 100	nA
Zero Gate Voltage Drain Current	I_{DSS}	$V_{DS} = -16V, V_{GS} = 0V$			-1	μA
		$V_{DS} = -16V, V_{GS} = 0V, T_J = 125\text{ }^\circ\text{C}$			-10	
On-State Drain Current ¹	$I_{D(ON)}$	$V_{DS} = -5V, V_{GS} = -4.5V$	-3.4			A
Drain-Source On-State Resistance ¹	$R_{DS(ON)}$	$V_{GS} = -4.5V, I_D = -3.4A$		83	100	m Ω
		$V_{GS} = -2.5V, I_D = -2.5A$		110	135	
Forward Transconductance ¹	g_{fs}	$V_{DS} = -5V, I_D = -3A$		4.5		S
DYNAMIC						
Input Capacitance	C_{iss}	$V_{GS} = 0V, V_{DS} = -10V, f = 1MHz$		450		pF
Output Capacitance	C_{oss}			58		
Reverse Transfer Capacitance	C_{rss}			41		
Total Gate Charge ^{1,2}	Q_g	$V_{DS} = -10V, V_{GS} = -4.5V,$ $I_D = -3A$		5.4		nC
Gate-Source Charge ^{1,2}	Q_{gs}			1.0		
Gate-Drain Charge ^{1,2}	Q_{gd}			1.3		
Turn-On Delay Time ^{1,2}	$t_{d(on)}$	$V_{DS} = -10V,$ $I_D = -1A, V_{GS} = -4.5V, R_{GS} = 6\Omega$		10		nS
Rise Time ^{1,2}	t_r			20		
Turn-Off Delay Time ^{1,2}	$t_{d(off)}$			15		
Fall Time ^{1,2}	t_f			12		
SOURCE-DRAIN DIODE RATINGS AND CHARACTERISTICS ($T_c = 25\text{ }^\circ\text{C}$)						
Continuous Current	I_S				-2	A
Pulsed Current ³	I_{SM}				-8	
Forward Voltage ¹	V_{SD}	$I_F = I_S, V_{GS} = 0V$			1.2	V

¹Pulse test : Pulse Width $\leq 300\text{ }\mu\text{sec}$, Duty Cycle $\leq 2\%$.

²Independent of operating temperature.

³Pulse width limited by maximum junction temperature.

EMC will review datasheet by quarter, and update new version.

TYPICAL CHARACTERISTICS

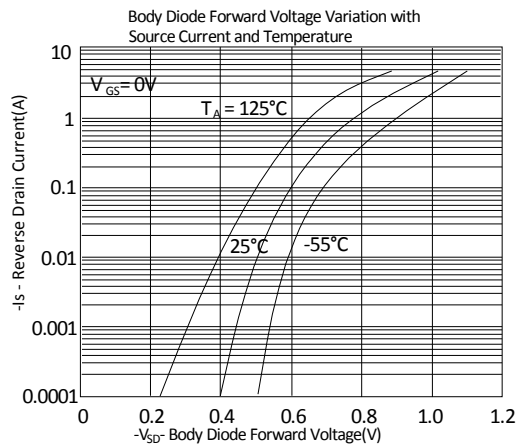
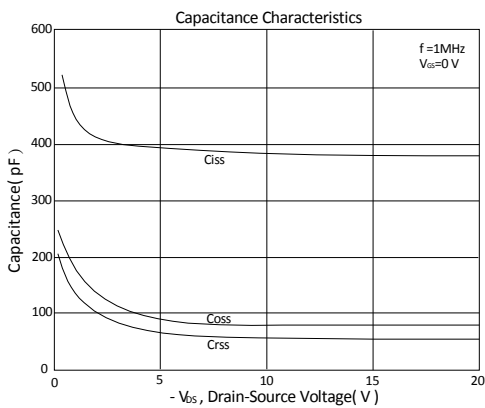
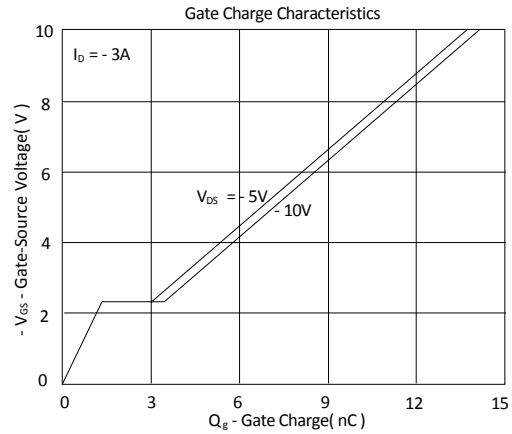
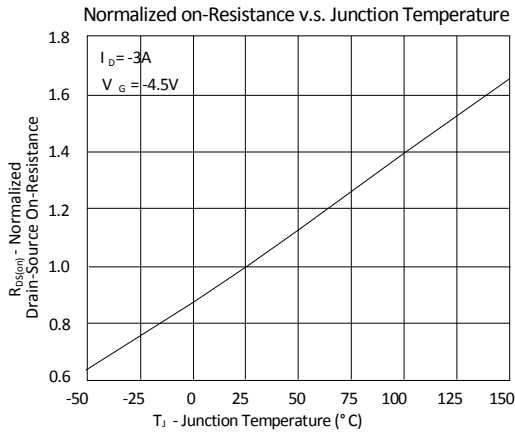
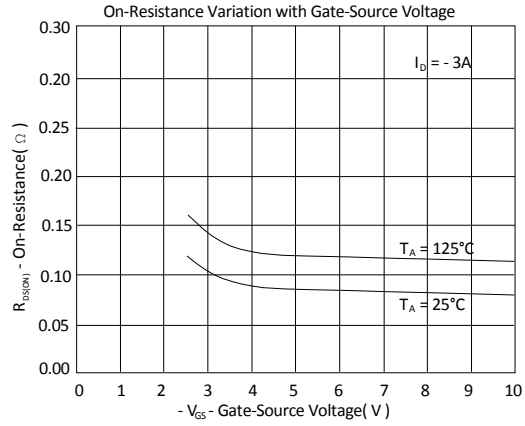
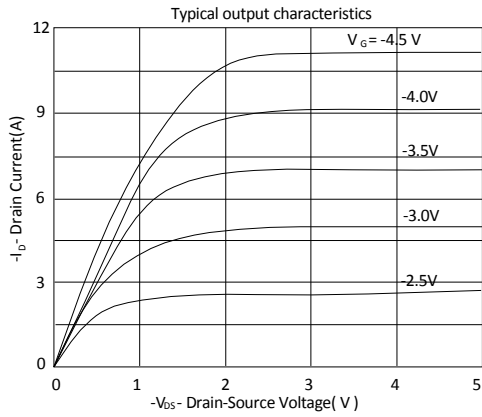

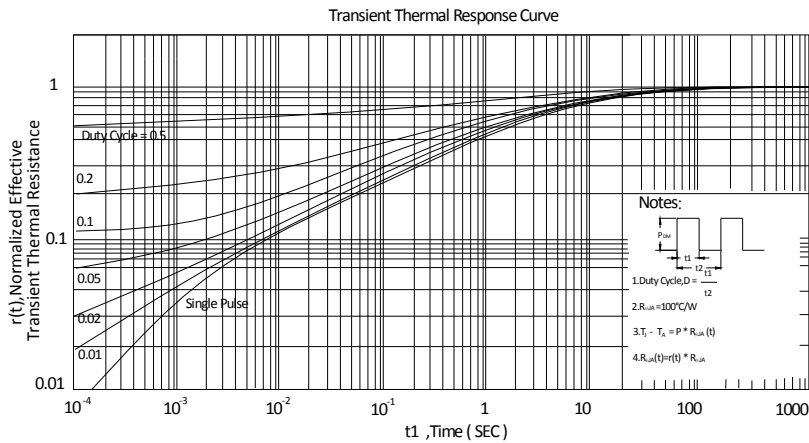
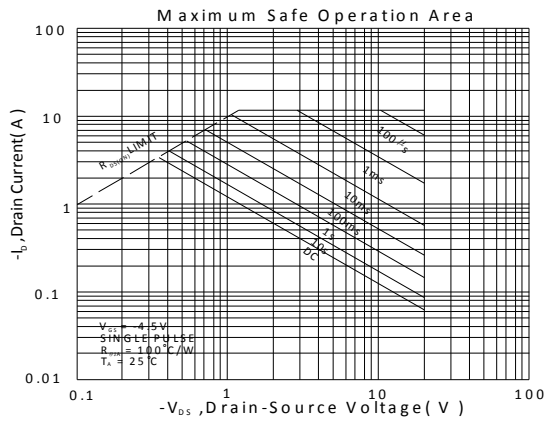
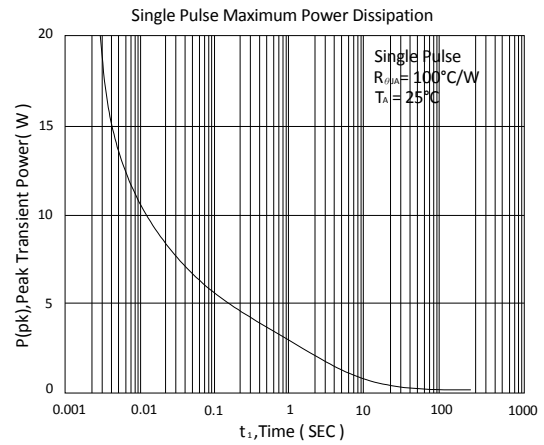
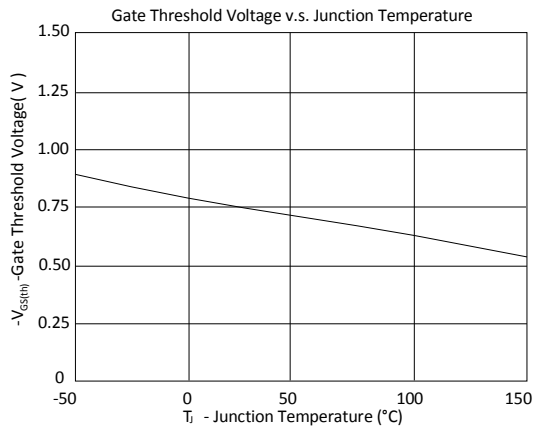

Ordering & Marking Information:

Device Name: EMFA0P02JS for SOT23-3

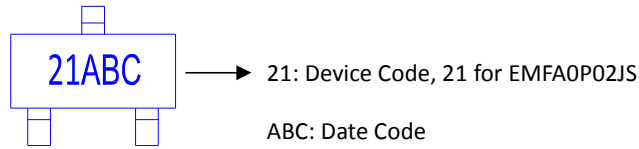

Outline Drawing

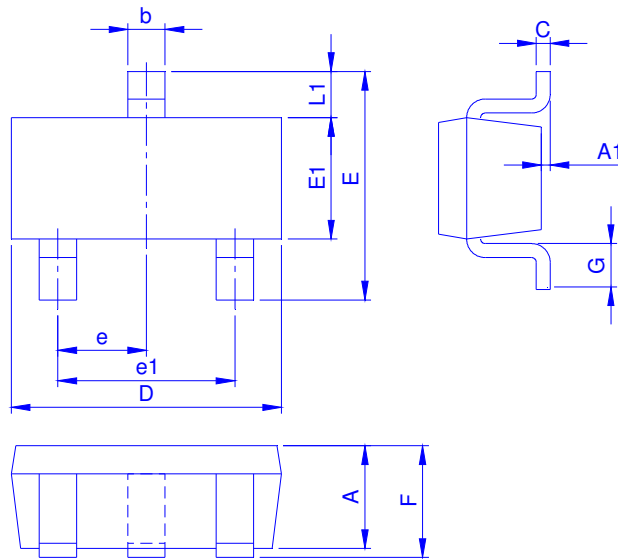

Dimension in mm

Dimension	A	A1	b	C	D	E	E1	e	e1	F	G	L1
Min.	0.70	-	0.30	0.080	2.80	2.10	1.20	0.90	1.80	0.80	0.30	0.54
Typ.	0.95	-	0.40	0.127	2.90	2.50	1.30	0.95	1.90	0.95	0.40	0.57
Max.	1.20	0.15	0.50	0.202	3.10	3.00	1.80	1.00	2.00	1.25	0.60	0.70

Footprint

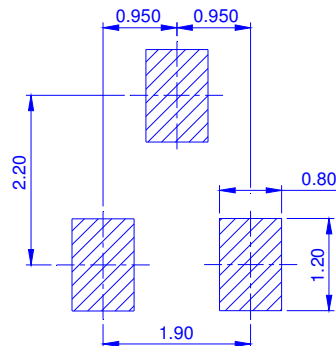



◆ Tape&Reel Information:3000pcs/Reel(Dimension in millimeter)

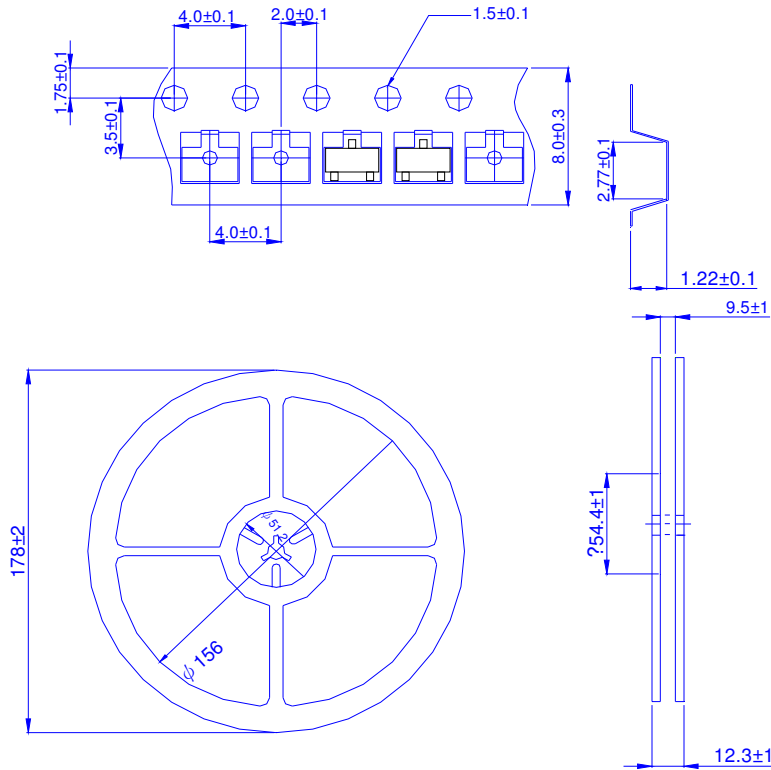

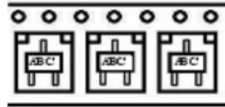
產品別	SOT23-3
Reel 尺寸	7"
編帶方式	FEED DIRECTION 
前空格	50
後空格	50
裝箱數	
滿捲數量	3K
捲/內盒比	5 : 1
內盒滿箱數	15K
內/外箱比	12 : 1