

N-Channel Logic Level Enhancement Mode Field Effect Transistor

Product Summary:

BV_{DSS}	30V
$R_{DS(on)} (MAX.)$	50m Ω
I_D	3.5A

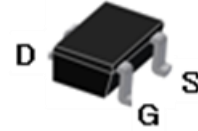
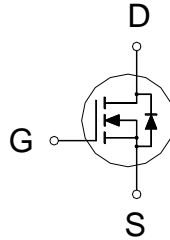

Pb-Free Lead Plating & Halogen Free



ABSOLUTE MAXIMUM RATINGS ($T_A = 25\text{ }^\circ\text{C}$ Unless Otherwise Noted)

PARAMETERS/TEST CONDITIONS		SYMBOL	LIMITS	UNIT
Gate-Source Voltage		V_{GS}	± 12	V
Continuous Drain Current	$T_A = 25\text{ }^\circ\text{C}$	I_D	3.5	A
	$T_A = 70\text{ }^\circ\text{C}$		2.4	
Pulsed Drain Current ¹		I_{DM}	14	
Power Dissipation	$T_A = 25\text{ }^\circ\text{C}$	P_D	1.25	W
	$T_A = 70\text{ }^\circ\text{C}$		0.8	
Operating Junction & Storage Temperature Range		T_j, T_{stg}	-55 to 150	$^\circ\text{C}$

THERMAL RESISTANCE RATINGS

THERMAL RESISTANCE	SYMBOL	TYPICAL	MAXIMUM	UNIT
Junction-to-Ambient ³	$R_{\theta JA}$		100	$^\circ\text{C} / \text{W}$
Junction-to-Lead ⁴	$R_{\theta JL}$		55	

¹Pulse width limited by maximum junction temperature.

²Duty cycle $\leq 1\%$

³100 $^\circ\text{C} / \text{W}$ when mounted on a 1 in² pad of 2 oz copper.

⁴ $R_{\theta JA}$ is the sum of the thermal impedance from junction to lead $R_{\theta JL}$ and lead to ambient.

ELECTRICAL CHARACTERISTICS (T_J = 25 °C, Unless Otherwise Noted)

PARAMETER	SYMBOL	TEST CONDITIONS	LIMITS			UNIT
			MIN	TYP	MAX	
STATIC						
Drain-Source Breakdown Voltage	V _{(BR)DSS}	V _{GS} = 0V, I _D = 250μA	30			V
Gate Threshold Voltage	V _{GS(th)}	V _{DS} = V _{GS} , I _D = 250μA	0.45	0.75	1.2	
Gate-Body Leakage	I _{GSS}	V _{DS} = 0V, V _{GS} = ±12V			±100	nA
Zero Gate Voltage Drain Current	I _{DSS}	V _{DS} = 24V, V _{GS} = 0V			1	μA
		V _{DS} = 20V, V _{GS} = 0V, T _J = 125 °C			10	
On-State Drain Current ¹	I _{D(ON)}	V _{DS} = 5V, V _{GS} = 10V	3.5			A
Drain-Source On-State Resistance ¹	R _{DS(ON)}	V _{GS} = 4.5V, I _D = 3.5A		43	50	mΩ
		V _{GS} = 2.5V, I _D = 2A		60	80	
Forward Transconductance ¹	g _{fs}	V _{DS} = 5V, I _D = 3.5A		5		S
DYNAMIC						
Input Capacitance	C _{iss}	V _{GS} = 0V, V _{DS} = 10V, f = 1MHz		362		pF
Output Capacitance	C _{oss}			52		
Reverse Transfer Capacitance	C _{rss}			39		
Total Gate Charge ^{1,2}	Q _g	V _{DS} = 10V, V _{GS} = 4.5V, I _D = 3.5A		5.2		nC
Gate-Source Charge ^{1,2}	Q _{gs}			1.5		
Gate-Drain Charge ^{1,2}	Q _{gd}			1.8		
Turn-On Delay Time ^{1,2}	t _{d(on)}	V _{DS} = 10V, I _D = 1A, V _{GS} = 4.5V, R _{GS} = 6Ω		8		nS
Rise Time ^{1,2}	t _r			2.5		
Turn-Off Delay Time ^{1,2}	t _{d(off)}			20		
Fall Time ^{1,2}	t _f			5		
SOURCE-DRAIN DIODE RATINGS AND CHARACTERISTICS (T_C = 25 °C)						
Continuous Current	I _S				3	A
Pulsed Current ³	I _{SM}				12	
Forward Voltage ¹	V _{SD}	I _F = I _S , V _{GS} = 0V			1.2	V

¹Pulse test : Pulse Width ≤ 300 μsec, Duty Cycle ≤ 2%.

²Independent of operating temperature.

³Pulse width limited by maximum junction temperature.

EMC will review datasheet by quarter, and update new version.



TYPICAL CHARACTERISTICS

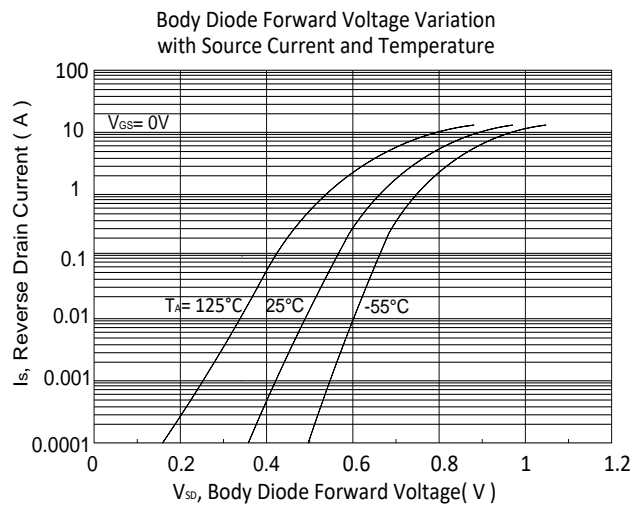
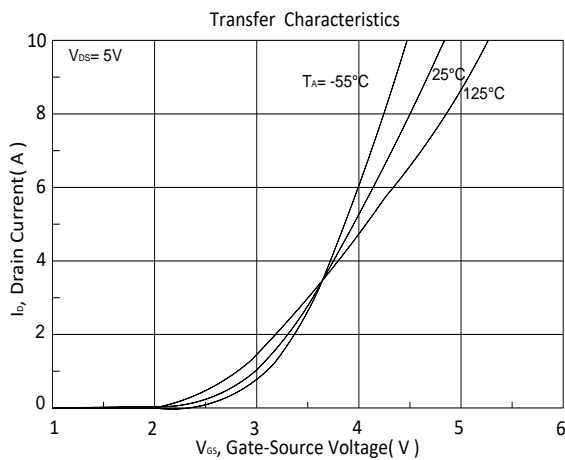
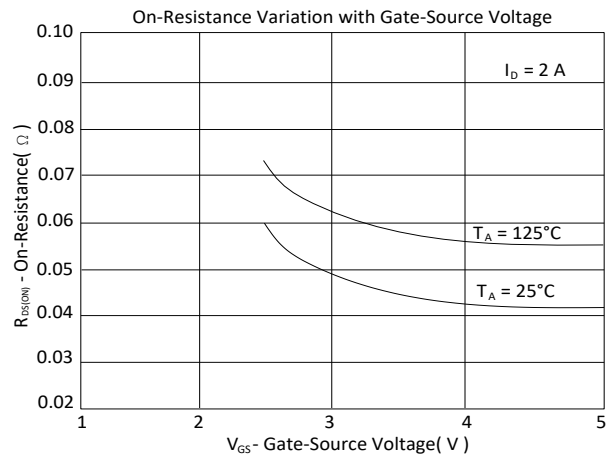
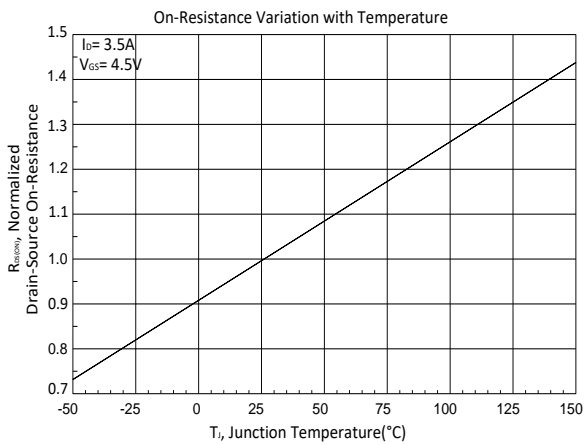
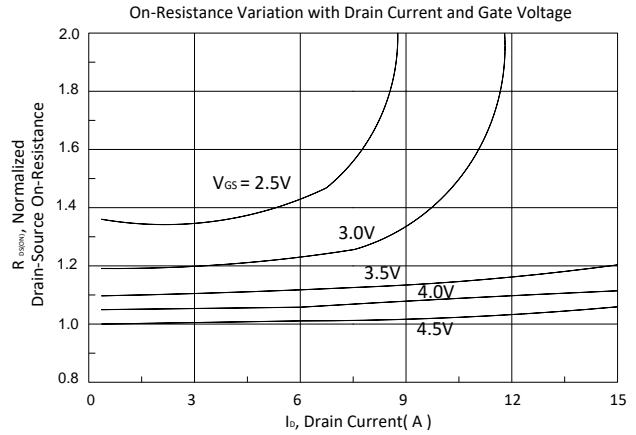
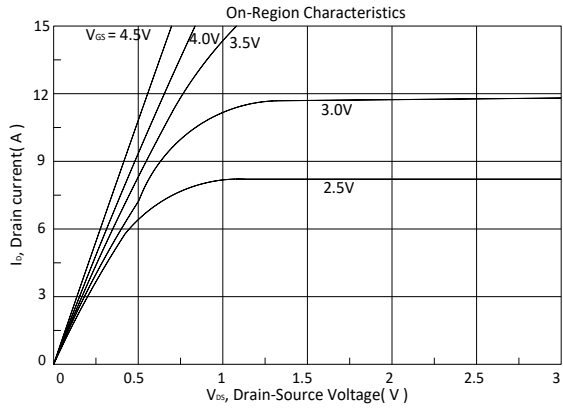

Ordering & Marking Information:

Device Name: EMF50N03J for SOT23-3

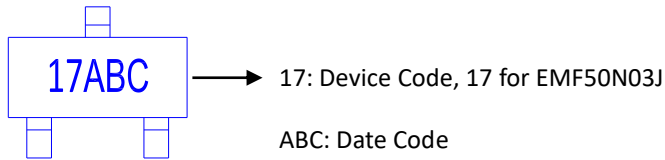

Outline Drawing

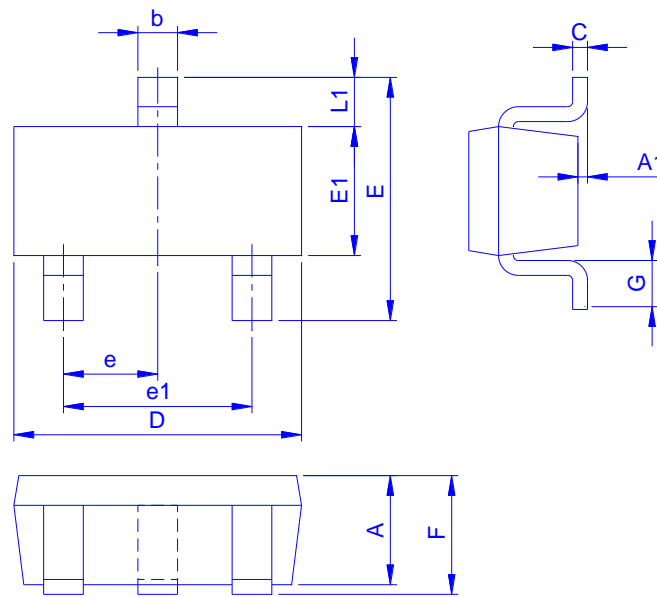

Dimension in mm

Dimension	A	A1	b	C	D	E	E1	e	e1	F	G	L1
Min.	0.70	-	0.30	0.080	2.80	2.10	1.20	0.90	1.80	0.80	0.30	0.54
Typ.	0.95	-	0.40	0.127	2.90	2.50	1.30	0.95	1.90	0.95	0.40	0.57
Max.	1.20	0.15	0.50	0.202	3.10	3.00	1.80	1.00	2.00	1.25	0.60	0.70

Footprint

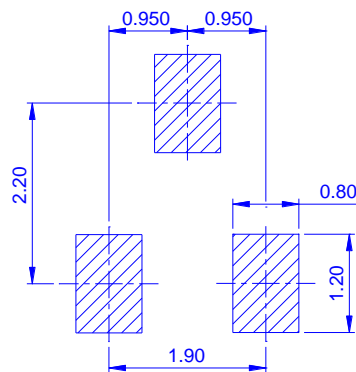

◆ Tape&Reel Information:3000pcs/Reel

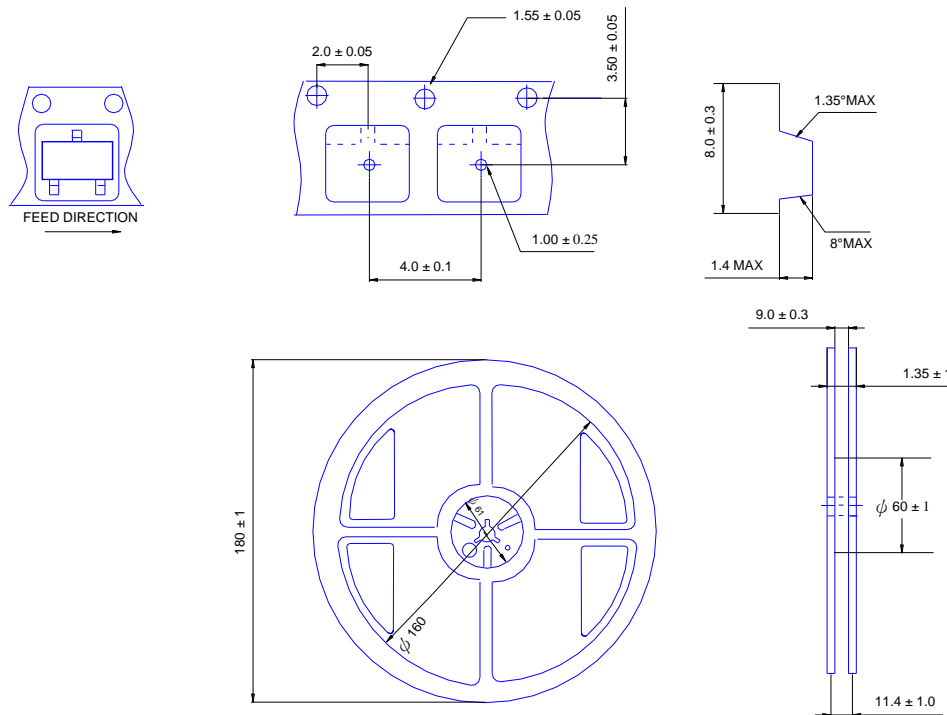

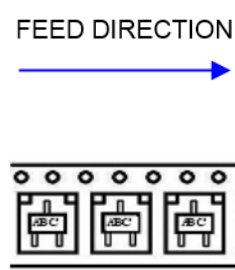
產品別	SOT23-3
Reel 尺寸	7"
編帶方式	FEED DIRECTION 
前空格	50
後空格	50
裝箱數	
滿捲數量	3K
捲/內盒比	5 : 1
內盒滿箱數	15K
內/外箱比	12 : 1
外箱滿箱數	180K