

P-Channel Logic Level Enhancement Mode Field Effect Transistor

Product Summary:

BV _{DSS}	-12V
R _{DS(on)} (MAX.)	20mΩ
I _D	-18A

P-Channel MOSFET

UIS, R_g 100% Tested

Pb-Free Lead Plating & Halogen Free

ABSOLUTE MAXIMUM RATINGS (T_A = 25 °C Unless Otherwise Noted)

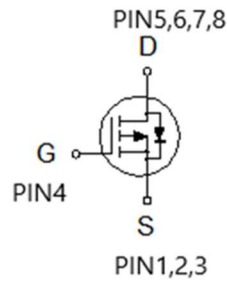

PARAMETERS/TEST CONDITIONS		SYMBOL	LIMITS	UNIT
Gate-Source Voltage		V _{GS}	±8	V
Continuous Drain Current	T _C = 25 °C	I _D	-18	A
	T _A = 25 °C		-9	
	T _C = 100 °C		-12	
Pulsed Drain Current ¹		I _{DM}	-72	
Power Dissipation	T _C = 25 °C	P _D	21	W
	T _C = 100 °C		8.3	
Power Dissipation	T _A = 25 °C	P _D	2.5	W
	T _A = 70 °C		1.6	
Operating Junction & Storage Temperature Range		T _J , T _{stg}	-55 to 150	°C

THERMAL RESISTANCE RATINGS

THERMAL RESISTANCE	SYMBOL	TYPICAL	MAXIMUM	UNIT
Junction-to-Case	R _{θJC}		6	°C / W
Junction-to-Ambient ³	R _{θJA}		50	

¹Pulse width limited by maximum junction temperature.

²Duty cycle ≤ 1%

³50°C / W when mounted on a 1 in² pad of 2 oz copper.



ELECTRICAL CHARACTERISTICS (T_J = 25 °C, Unless Otherwise Noted)

PARAMETER	SYMBOL	TEST CONDITIONS	LIMITS			UNIT		
			MIN	TYP	MAX			
STATIC								
Drain-Source Breakdown Voltage	V _{(BR)DSS}	V _{GS} = 0V, I _D = -250μA	-12			V		
Gate Threshold Voltage	V _{GS(th)}	V _{DS} = V _{GS} , I _D = -250μA	-0.4	-0.75	-1.2			
Gate-Body Leakage	I _{GSS}	V _{DS} = 0V, V _{GS} = ±8V			±100	nA		
Zero Gate Voltage Drain Current	I _{DSS}	V _{DS} = -12V, V _{GS} = 0V			-1	μA		
		V _{DS} = -10V, V _{GS} = 0V, T _J = 125 °C			-10			
On-State Drain Current ¹	I _{D(ON)}	V _{DS} = -5V, V _{GS} = -4.5V	-18			A		
Drain-Source On-State Resistance ¹	R _{DS(ON)}	V _{GS} = -4.5V, I _D = -9A		15	20	mΩ		
		V _{GS} = -2.5V, I _D = -5A		19	25			
		V _{GS} = -1.8V, I _D = -3A		26	40			
Forward Transconductance ¹	g _{fs}	V _{DS} = -5V, I _D = -9A		22		S		
DYNAMIC								
Input Capacitance	C _{iss}	V _{GS} = 0V, V _{DS} = -6V, f = 1MHz		3100		pF		
Output Capacitance	C _{oss}			460				
Reverse Transfer Capacitance	C _{rss}			413				
Total Gate Charge ^{1,2}	Q _g (V _{GS} =-4.5V)	V _{DS} = -6V, V _{GS} = -4.5V, I _D = -9A		25.5		nC		
	Q _g (V _{GS} =-2.5V)			15				
Gate-Source Charge ^{1,2}	Q _{gs}			2.2				
Gate-Drain Charge ^{1,2}	Q _{gd}			5.7				
Turn-On Delay Time ^{1,2}	t _{d(on)}		V _{DS} = -6V, I _D = -1A, V _{GS} = -4.5V, R _{GS} = 6Ω		20			nS
Rise Time ^{1,2}	t _r				50			
Turn-Off Delay Time ^{1,2}	t _{d(off)}			95				
Fall Time ^{1,2}	t _f			60				
SOURCE-DRAIN DIODE RATINGS AND CHARACTERISTICS (T_C = 25 °C)								
Continuous Current	I _S				-18	A		
Pulsed Current ³	I _{SM}				-72			
Forward Voltage ¹	V _{SD}	I _F = -9A, V _{GS} = 0V			-1.2	V		

¹Pulse test : Pulse Width ≤ 300 μsec, Duty Cycle ≤ 2%.

²Independent of operating temperature.

³Pulse width limited by maximum junction temperature.

EMC will review datasheet by quarter, and update new version.



TYPICAL CHARACTERISTICS

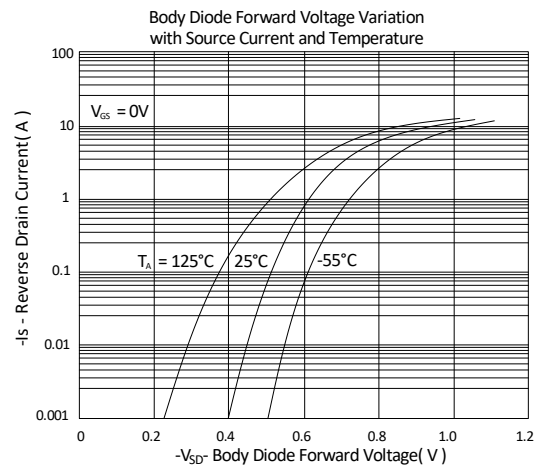
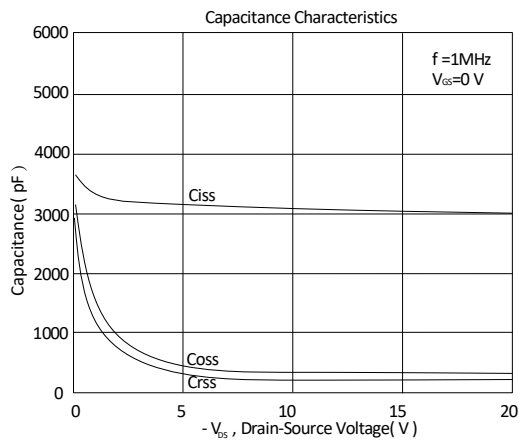
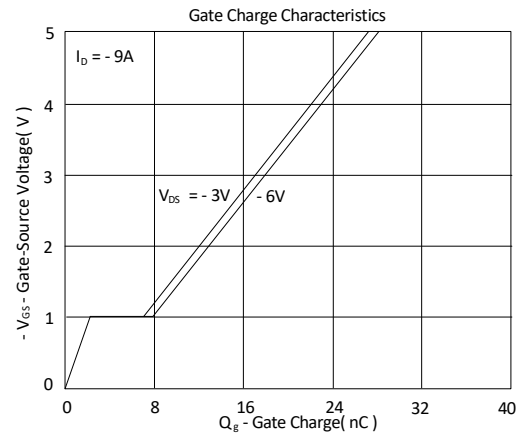
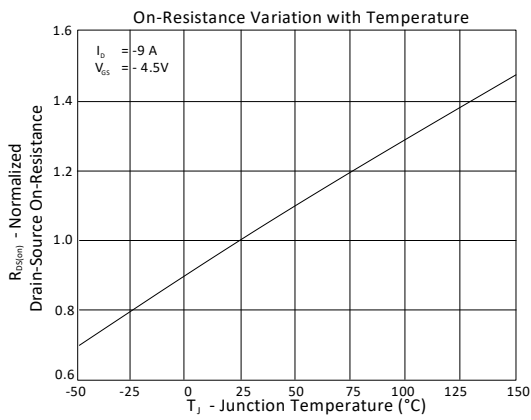
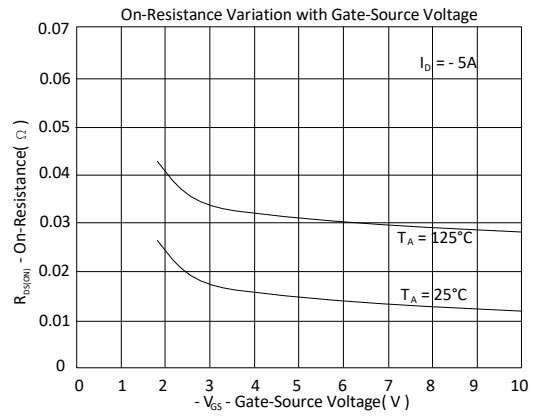
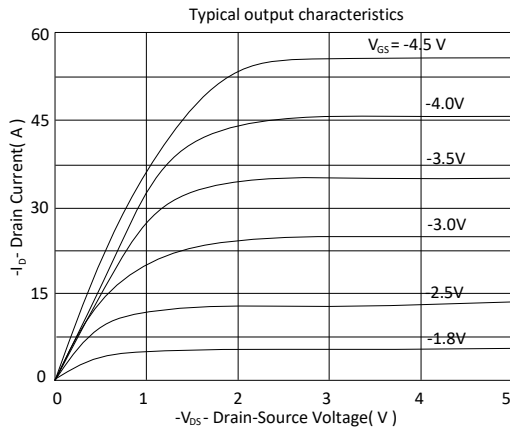

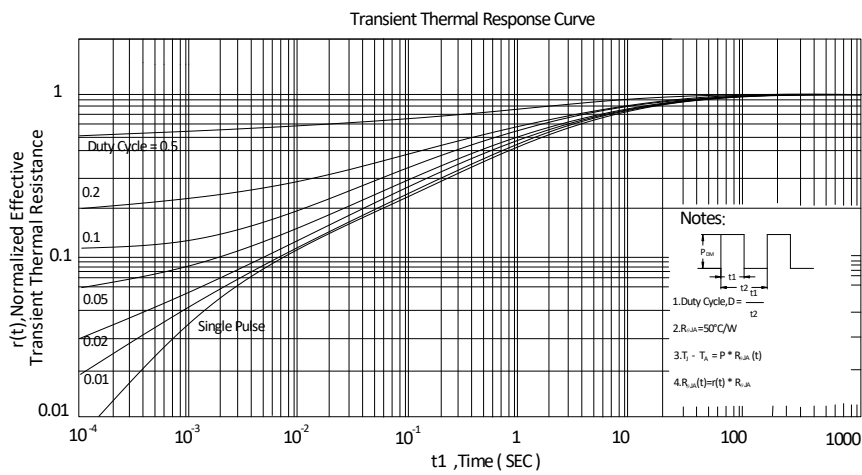
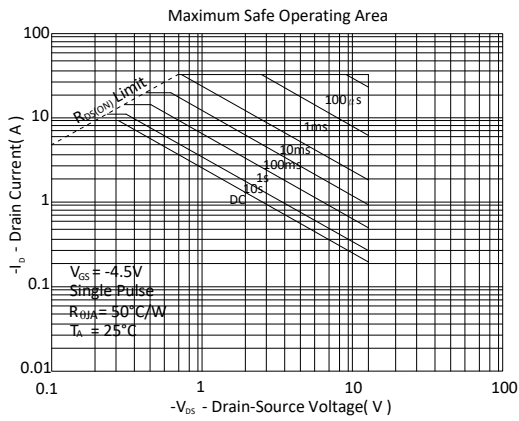
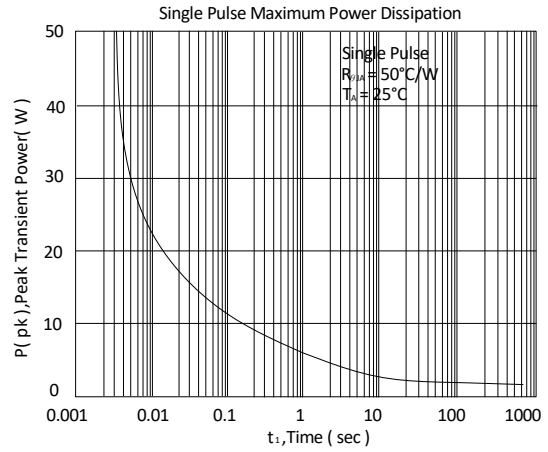
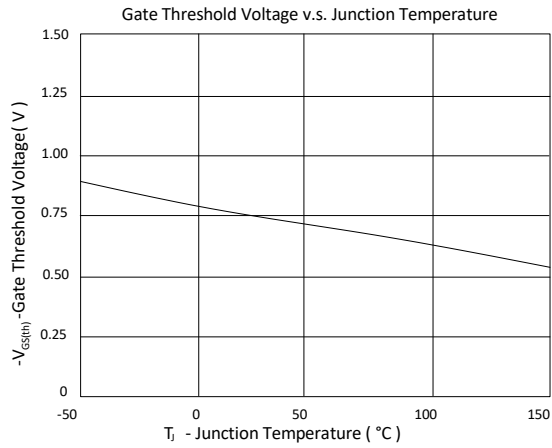

Ordering & Marking Information:

Device Name: EMF20P02V for EDFN3X3

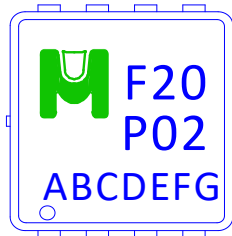

F20P02: Device Name

ABCDEFG: Date Code

A: Assembly House

B: Year(A:2008 B:2009 C:2010....)

C: Month(A:01 B:02 C:03 D:04 E:05 F:06 G:07 H:08 I:09 J:10 K:11 L:12)

DEFG: Serial No.

Outline Drawing

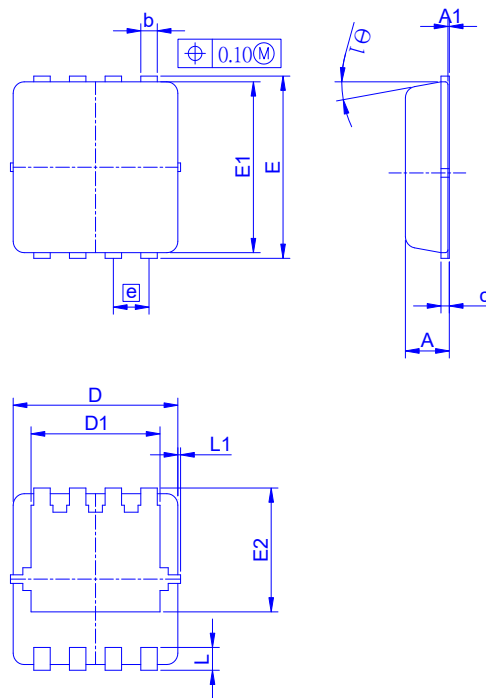

Dimension in mm

Dimension	A	A1	b	c	D	D1	E	E1	E2	e	L	L1	$\theta 1$
Min.	0.65	0	0.20	0.10	2.90	2.15	3.10	2.90	1.53	0.55	0.25	-	0°
Typ.	0.75	-	0.30	0.15	3.00	2.45	3.20	3.00	1.97	0.65	0.40	0.075	10°
Max.	0.90	0.05	0.40	0.25	3.30	2.74	3.50	3.30	2.59	0.75	0.60	0.150	14°

Recommended minimum pads

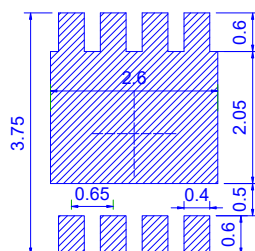



Tape&Reel Information: 5000pcs/Reel

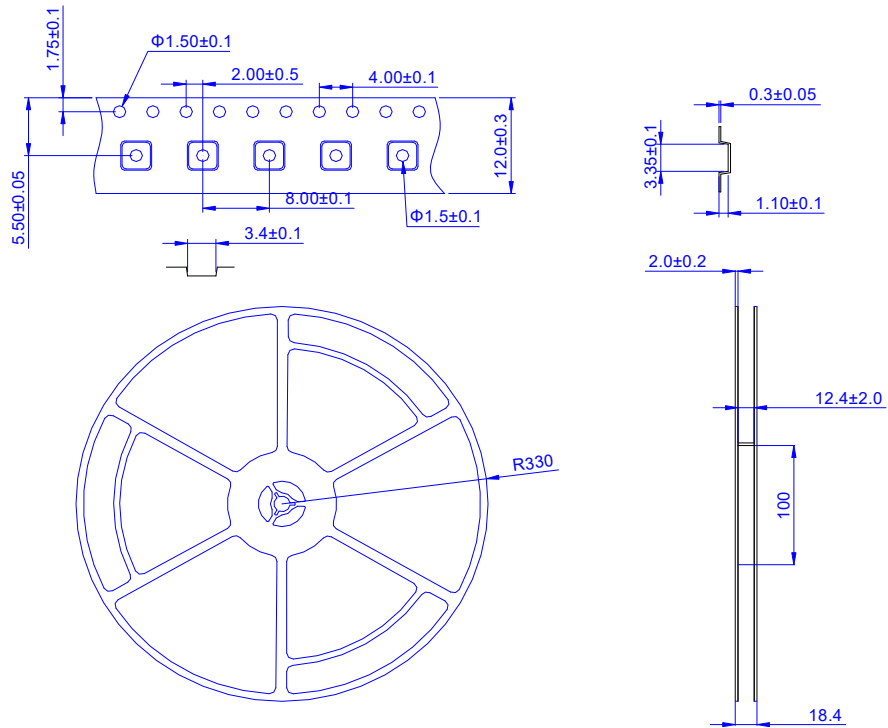

產品別	EDFN3X3
Reel 尺寸	13"
編帶方式	<p>FEEED DIRECTION</p>
前空格	50
後空格	50
裝箱數	
滿捲數量	5K
捲/內盒比	1 : 1
內盒滿箱數	5K
內/外箱比	10 : 1
外箱滿箱數	50K