

Single N-Channel Logic Level Enhancement Mode Field Effect Transistor

Product Summary:

BV _{DSS}	100V
R _{DSON (MAX.)}	60mΩ
I _D	20A

Pin Description:

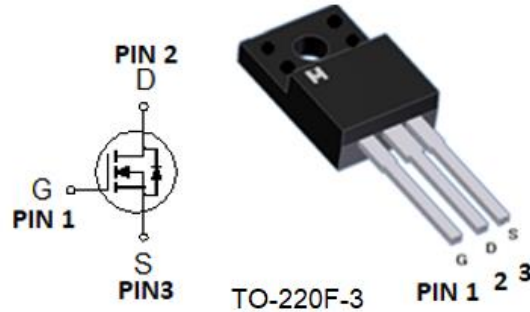

Single N Channel MOSFET

UIS, R_g 100% Tested

Pb-Free Lead Plating & Halogen Free



ABSOLUTE MAXIMUM RATINGS (T_c = 25 °C Unless Otherwise Noted)

PARAMETERS/TEST CONDITIONS		SYMBOL	LIMITS	UNIT
Gate-Source Voltage		V _{GS}	±25	V
Continuous Drain Current	T _c = 25 °C	I _D	20	A
	T _c = 100 °C		12	
Pulsed Drain Current ¹		I _{DM}	80	
Avalanche Current		I _{AS}	20	
Avalanche Energy	L = 0.1mH, I _D =20A, R _G =25Ω	E _{AS}	20	mJ
Repetitive Avalanche Energy ²	L = 0.05mH	E _{AR}	10	
Power Dissipation	T _c = 25 °C	P _D	30	W
	T _c = 100 °C		12	
Operating Junction & Storage Temperature Range		T _j , T _{stg}	-55 to 150	°C

THERMAL RESISTANCE RATINGS

THERMAL RESISTANCE	SYMBOL	TYPICAL	MAXIMUM	UNIT
Junction-to-Case	R _{θJC}		4.1	°C / W
Junction-to-Ambient	R _{θJA}		62.5	

¹Pulse width limited by maximum junction temperature.

²Duty cycle ≤ 1%

³Pulsed drain current rating is package limited.



ELECTRICAL CHARACTERISTICS (T_c = 25 °C, Unless Otherwise Noted)

PARAMETER	SYMBOL	TEST CONDITIONS	LIMITS			UNIT
			MIN	TYP	MAX	
STATIC						
Drain-Source Breakdown Voltage	V _{(BR)DSS}	V _{GS} = 0V, I _D = 250μA	100			V
Gate Threshold Voltage	V _{GS(th)}	V _{DS} = V _{GS} , I _D = 250μA	2.0	3.0	4.0	
Gate-Body Leakage	I _{GSS}	V _{DS} = 0V, V _{GS} = ±25V			±100	nA
Zero Gate Voltage Drain Current	I _{DSS}	V _{DS} = 80V, V _{GS} = 0V			1	μA
		V _{DS} = 70V, V _{GS} = 0V, T _J = 125 °C			25	
On-State Drain Current ¹	I _{D(ON)}	V _{DS} = 10V, V _{GS} = 10V	20			A
Drain-Source On-State Resistance ¹	R _{DS(ON)}	V _{GS} = 10V, I _D = 12A		50	60	mΩ
Forward Transconductance ¹	g _{fs}	V _{DS} = 5V, I _D = 12A		22		S
DYNAMIC						
Input Capacitance	C _{iss}	V _{GS} = 0V, V _{DS} = 30V, f = 1MHz		770		pF
Output Capacitance	C _{oss}			130		
Reverse Transfer Capacitance	C _{rss}			33		
Gate Resistance	R _g	V _{GS} = 15mV, V _{DS} = 0V, f = 1MHz		1.5		Ω
Total Gate Charge ^{1,2}	Q _g	V _{DS} = 50V, V _{GS} = 10V, I _D = 12A		13.6		nC
Gate-Source Charge ^{1,2}	Q _{gs}			4.5		
Gate-Drain Charge ^{1,2}	Q _{gd}			6		
Turn-On Delay Time ^{1,2}	t _{d(on)}	V _{DS} = 50V, I _D = 1A, V _{GS} = 10V, R _{GS} = 6Ω		10		nS
Rise Time ^{1,2}	t _r			15		
Turn-Off Delay Time ^{1,2}	t _{d(off)}			20		
Fall Time ^{1,2}	t _f			18		
SOURCE-DRAIN DIODE RATINGS AND CHARACTERISTICS (T_c = 25 °C)						
Continuous Current	I _S				20	A
Pulsed Current ³	I _{SM}				80	
Forward Voltage ¹	V _{SD}	I _F = 12A, V _{GS} = 0V			1.3	V
Reverse Recovery Time	t _{rr}	I _F = 12A, dI _F /dt = 100A / μS		45		nS
Reverse Recovery Charge	Q _{rr}				75	

¹Pulse test : Pulse Width ≤ 300 μsec, Duty Cycle ≤ 2%.

²Independent of operating temperature.

³Pulse width limited by maximum junction temperature.

Ordering & Marking Information:

Device Name: EMD60N10F for TO-220F

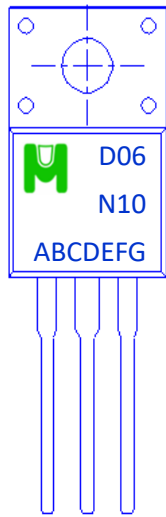

→ D60N10: Device Name

→ ABCDEFG: Date Code

A: Assembly House

B: Year(A:2008 B:2009 C:2010....)

C: Month(A:01 B:02 C:03 D:04 E:05 F:06 G:07 H:08 I:09 J:10 K:11 L:12)

DEFG: Serial No

Outline Drawing

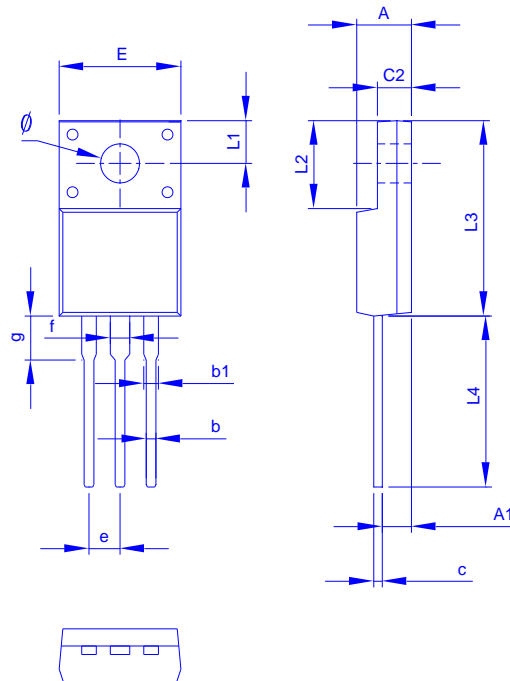

Dimension in mm

Dimension	A	A1	b	b1	c	c2	E	L1	L2	L3	L4	ø	e	f	g
Min.	4.3	2.49	0.5	1.1	0.4	2.34	9.96	2.7	6.48	14.8	12.65	3	2.44	1.17	2.93
Typ.	4.5	2.59	0.8	1.3	0.5	2.54	10.1	3.25	6.68	15.87	12.98	3.1	2.54	1.28	3.03
Max.	4.9	2.96	0.95	1.6	0.75	3.2	10.36	3.45	6.9	16.2	13.5	3.38	2.64	1.75	4



TYPICAL CHARACTERISTICS

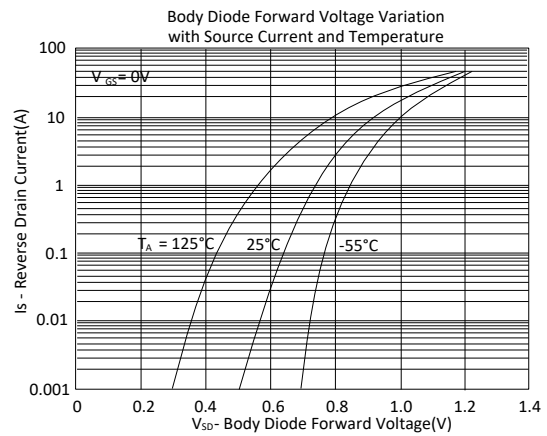
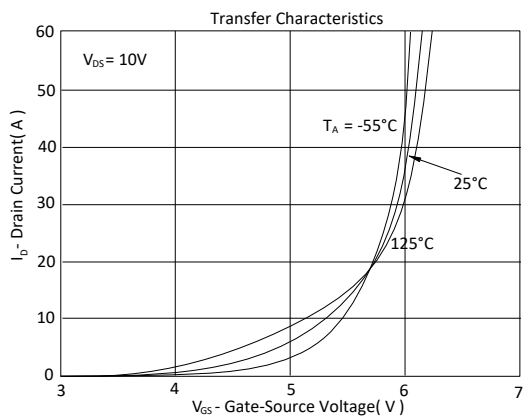
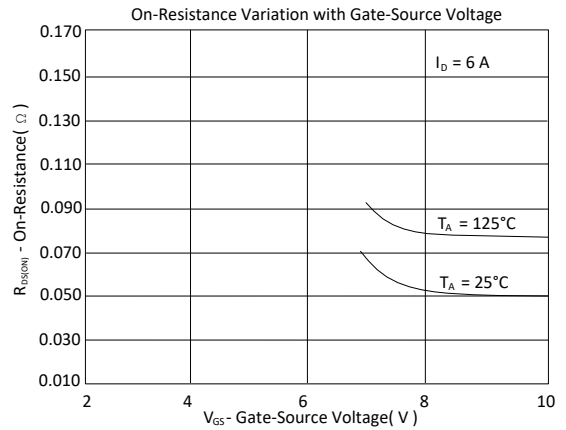
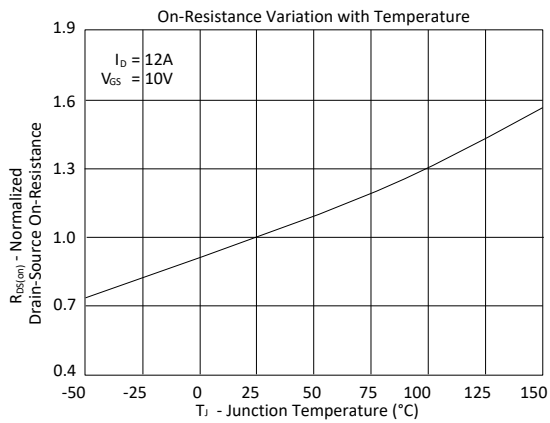
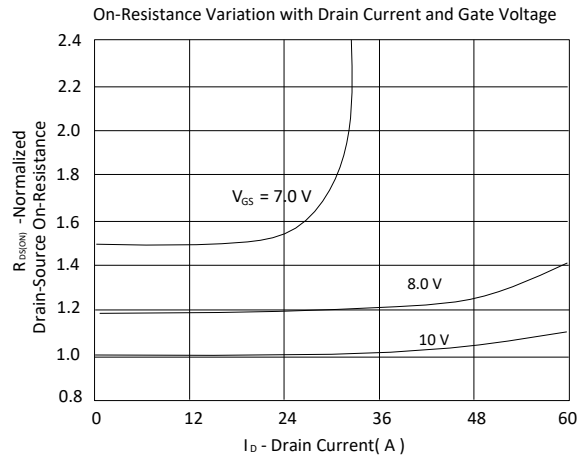
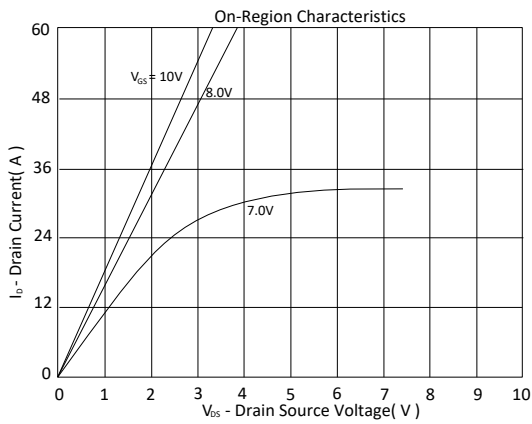

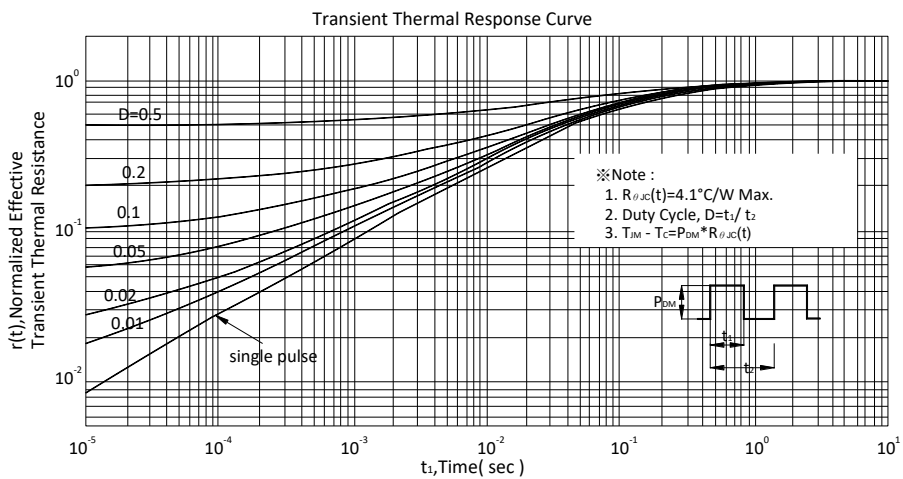
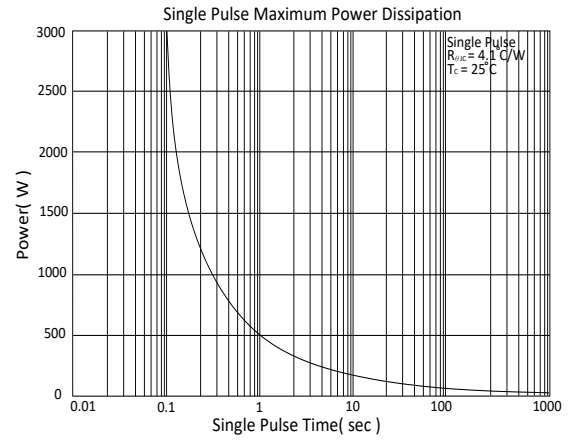
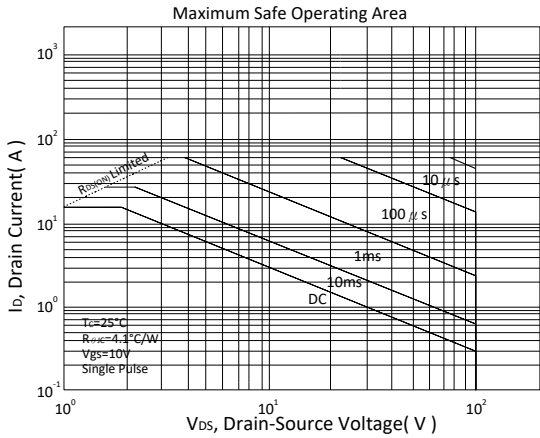
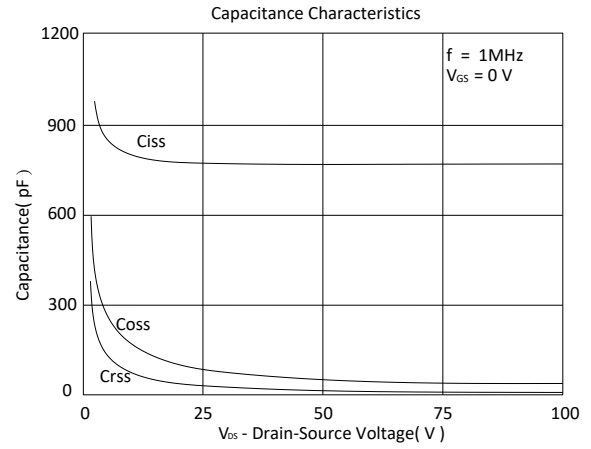
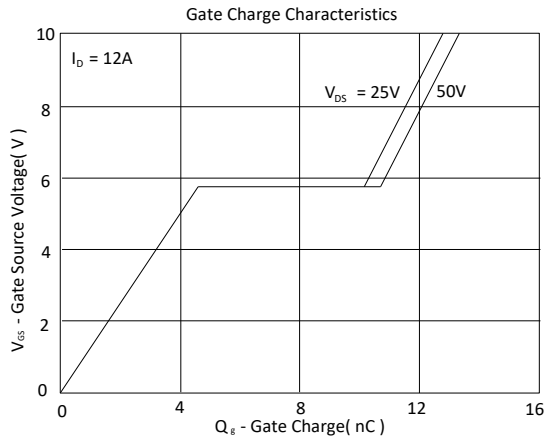



◆ Tube Information: 50pcs/Tube (1000pcs/Box)

