

N-Channel Logic Level Enhancement Mode Field Effect Transistor

Product Summary:

$BV_{DSS}$	80V
$R_{DS(on) (MAX.)}$	4.6m $\Omega$
$I_D$	160A

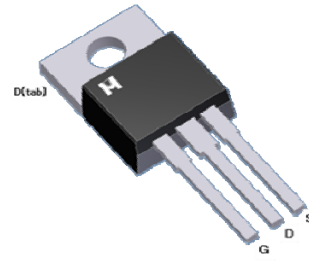

UIS, Rg 100% Tested

Pb-Free Lead Plating & Halogen Free



ABSOLUTE MAXIMUM RATINGS ( $T_A = 25\text{ }^\circ\text{C}$  Unless Otherwise Noted)

PARAMETERS/TEST CONDITIONS		SYMBOL	LIMITS	UNIT
Gate-Source Voltage		$V_{GS}$	$\pm 30$	V
Continuous Drain Current	$T_C = 25\text{ }^\circ\text{C}$	$I_D$	160	A
	$T_C = 100\text{ }^\circ\text{C}$		126	
Pulsed Drain Current <sup>1</sup>		$I_{DM}$	540	
Avalanche Current		$I_{AS}$	90	
Avalanche Energy	$L = 0.1\text{mH}, I_{AS}=90\text{A}, R_G=25\Omega$	$E_{AS}$	405	mJ
Repetitive Avalanche Energy <sup>2</sup>	$L = 0.05\text{mH}$	$E_{AR}$	202	
Power Dissipation	$T_C = 25\text{ }^\circ\text{C}$	$P_D$	250	W
	$T_C = 100\text{ }^\circ\text{C}$		100	
Operating Junction & Storage Temperature Range		$T_{j}, T_{stg}$	-55 to 150	$^\circ\text{C}$

100% UIS testing in condition of  $V_D=30\text{V}, L=0.1\text{mH}, V_G=10\text{V}, I_L=60\text{A}, \text{Rated } V_{DS}=80\text{V N-CH}$

THERMAL RESISTANCE RATINGS

THERMAL RESISTANCE	SYMBOL	TYPICAL	MAXIMUM	UNIT
Junction-to-Case	$R_{\theta JC}$		0.50	$^\circ\text{C} / \text{W}$
Junction-to-Ambient	$R_{\theta JA}$		60	

<sup>1</sup>Pulse width limited by maximum junction temperature.

<sup>2</sup>Duty cycle  $\leq 1\%$

ELECTRICAL CHARACTERISTICS (T<sub>J</sub> = 25 °C, Unless Otherwise Noted)

PARAMETER	SYMBOL	TEST CONDITIONS	LIMITS			UNIT
			MIN	TYP	MAX	
<b>STATIC</b>						
Drain-Source Breakdown Voltage	V <sub>(BR)DSS</sub>	V <sub>GS</sub> = 0V, I <sub>D</sub> = 250μA	80			V
Gate Threshold Voltage	V <sub>GS(th)</sub>	V <sub>DS</sub> = V <sub>GS</sub> , I <sub>D</sub> = 250μA	2.0	3.0	4.0	
Gate-Body Leakage	I <sub>GSS</sub>	V <sub>DS</sub> = 0V, V <sub>GS</sub> = ±30V			±100	nA
Zero Gate Voltage Drain Current	I <sub>DSS</sub>	V <sub>DS</sub> = 64V, V <sub>GS</sub> = 0V			1	μA
		V <sub>DS</sub> = 60V, V <sub>GS</sub> = 0V, T <sub>J</sub> = 125 °C			25	
On-State Drain Current <sup>1</sup>	I <sub>D(ON)</sub>	V <sub>DS</sub> = 10V, V <sub>GS</sub> = 10V	160			A
Drain-Source On-State Resistance <sup>1</sup>	R <sub>DS(ON)</sub>	V <sub>GS</sub> = 10V, I <sub>D</sub> = 50A		4.1	4.6	mΩ
Forward Transconductance <sup>1</sup>	g <sub>fs</sub>	V <sub>DS</sub> = 5V, I <sub>D</sub> = 50A		60		S
<b>DYNAMIC</b>						
Input Capacitance	C <sub>iss</sub>	V <sub>GS</sub> = 0V, V <sub>DS</sub> = 40V, f = 1MHz		5548		pF
Output Capacitance	C <sub>oss</sub>			557		
Reverse Transfer Capacitance	C <sub>rss</sub>			29		
Gate Resistance	R <sub>g</sub>	V <sub>GS</sub> = 15mV, V <sub>DS</sub> = 0V, f = 1MHz		1.8		Ω
Total Gate Charge <sup>1,2</sup>	Q <sub>g</sub>	V <sub>DS</sub> = 40V, V <sub>GS</sub> = 10V, I <sub>D</sub> = 50A		58		nC
Gate-Source Charge <sup>1,2</sup>	Q <sub>gs</sub>			38		
Gate-Drain Charge <sup>1,2</sup>	Q <sub>gd</sub>			8.5		
Turn-On Delay Time <sup>1,2</sup>	t <sub>d(on)</sub>	V <sub>DS</sub> = 40V, I <sub>D</sub> = 1A, V <sub>GS</sub> = 10V, R <sub>GS</sub> = 6Ω		80		nS
Rise Time <sup>1,2</sup>	t <sub>r</sub>			150		
Turn-Off Delay Time <sup>1,2</sup>	t <sub>d(off)</sub>			100		
Fall Time <sup>1,2</sup>	t <sub>f</sub>			170		
<b>SOURCE-DRAIN DIODE RATINGS AND CHARACTERISTICS (T<sub>C</sub> = 25 °C)</b>						
Continuous Current	I <sub>S</sub>				160	A
Pulsed Current <sup>3</sup>	I <sub>SM</sub>				540	
Forward Voltage <sup>1</sup>	V <sub>SD</sub>	I <sub>F</sub> = 50A, V <sub>GS</sub> = 0V			1.3	V
Reverse Recovery Time	t <sub>rr</sub>	I <sub>F</sub> = 20A, dI <sub>F</sub> /dt = 100A / μS		70		nS
Reverse Recovery Charge	Q <sub>rr</sub>				250	

<sup>1</sup>Pulse test : Pulse Width ≤ 300 μsec, Duty Cycle ≤ 2%.

<sup>2</sup>Independent of operating temperature.

<sup>3</sup>Pulse width limited by maximum junction temperature.

Ordering & Marking Information:

Device Name: EMD04N08E for TO-220

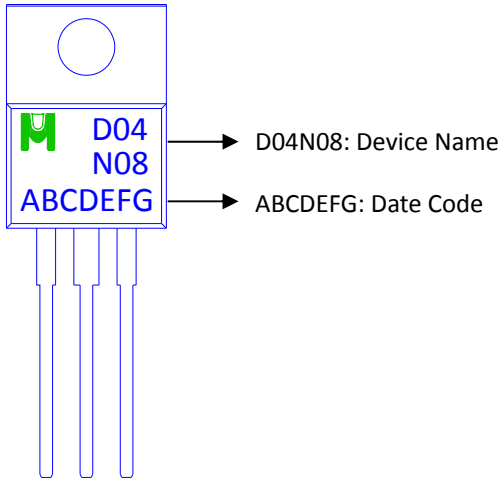



TYPICAL CHARACTERISTICS

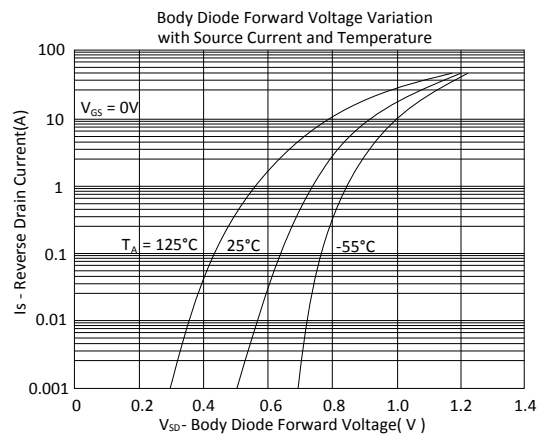
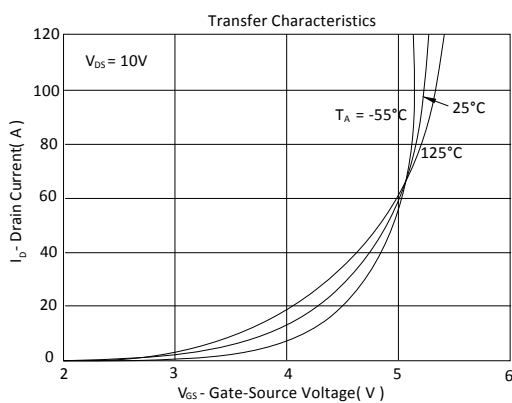
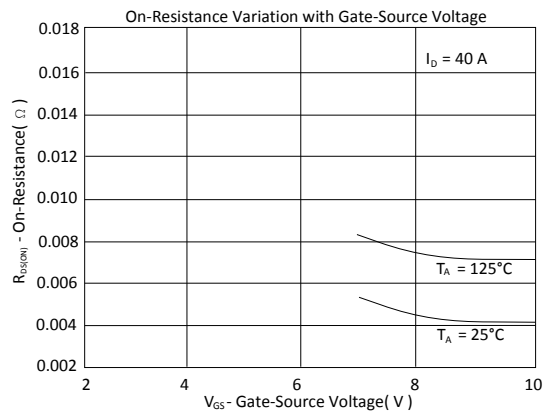
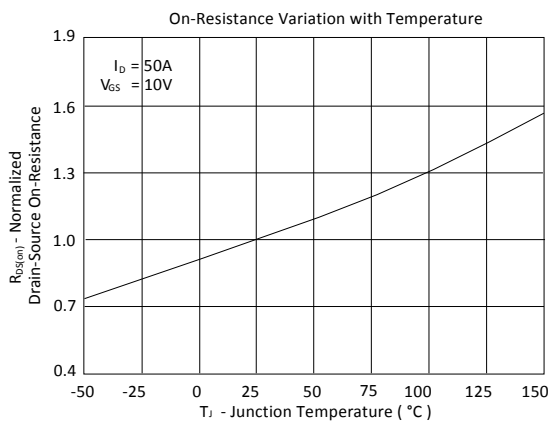
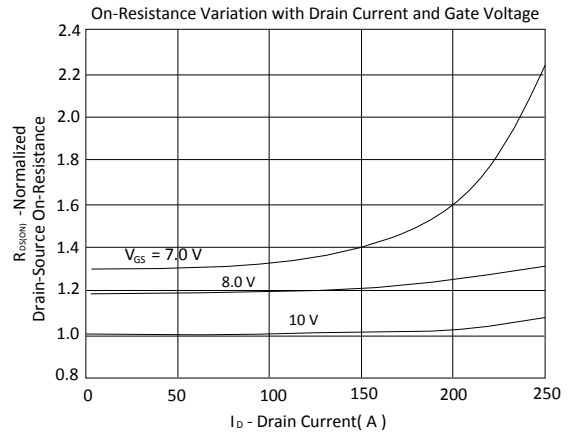
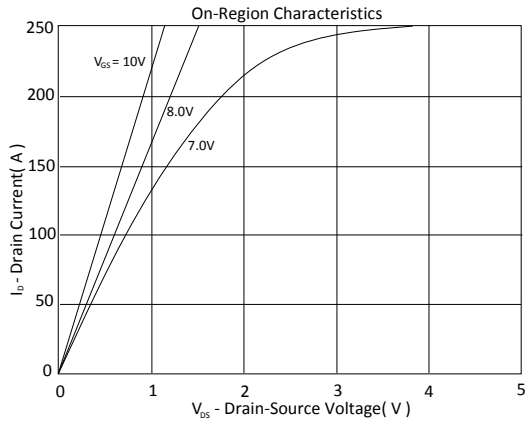

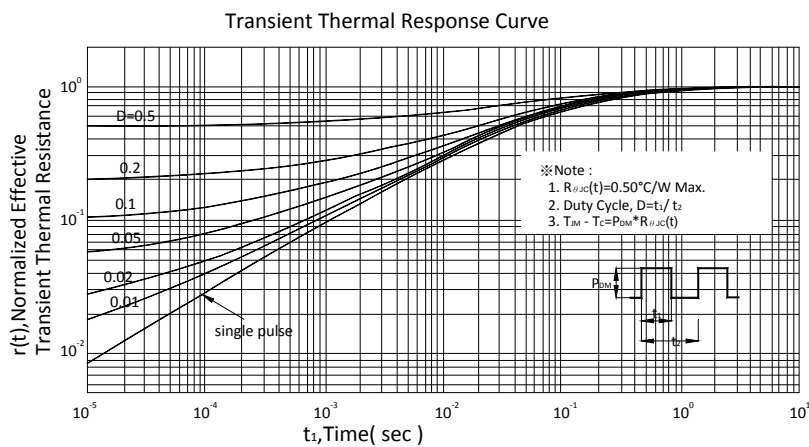
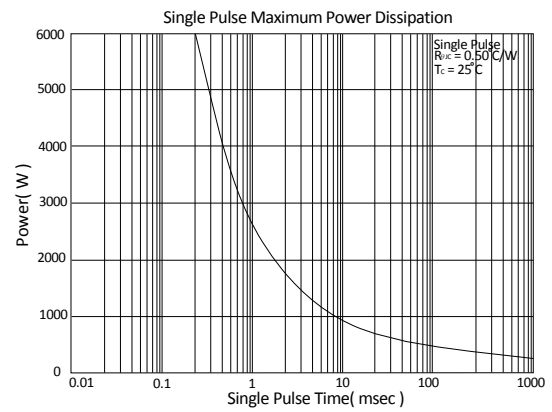
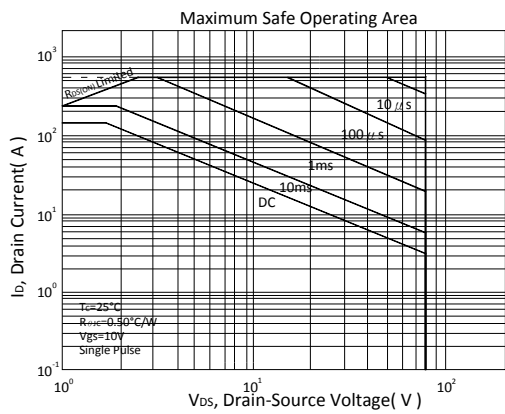
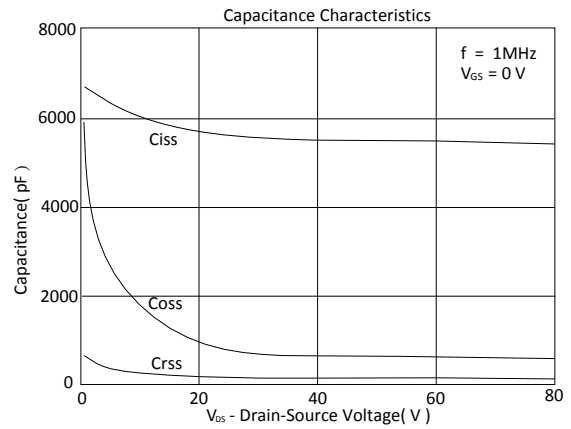
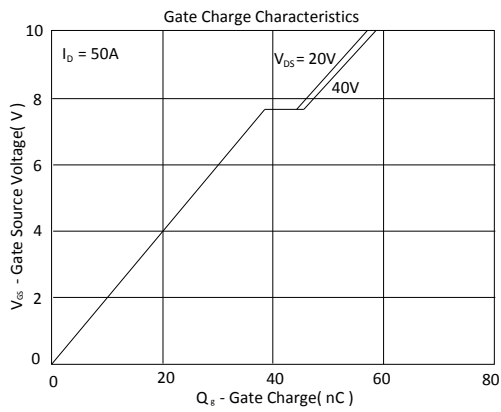



Outline Drawing

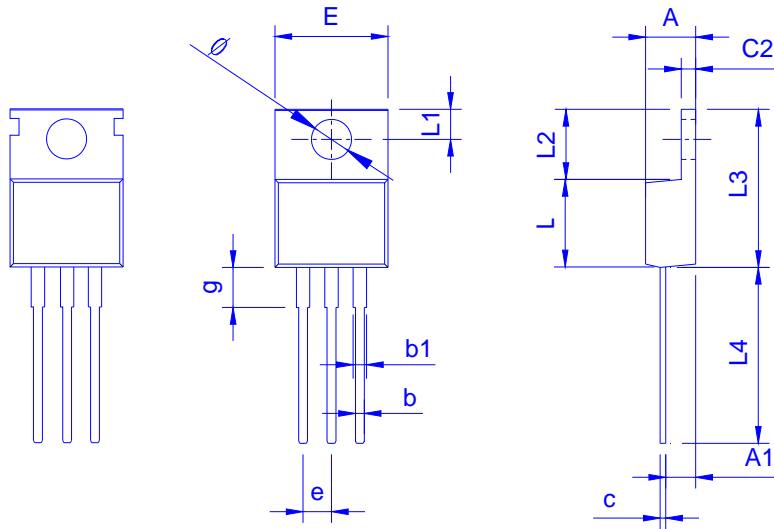

Dimension in mm

Dimension	A	A1	b	b1	c	c2	E	L	L1	L2	L3	L4	$\phi$	e	g
Min.	4.07	2.04	0.60	1.15	0.31	1.11	9.90	8.30	2.50	6.00	14.30	12.70	3.40	2.04	2.85
Typ.	4.44	2.40	0.80	1.27	-	1.27	10.16	-	2.74	6.30	15.00	13.40	3.84	2.54	3.71
Max.	4.82	3.00	1.00	1.75	0.65	1.41	11.50	9.75	3.25	6.80	16.90	14.50	4.00	3.04	4.10