

P-Channel Logic Level Enhancement Mode Field Effect Transistor

Product Summary:

BV _{DSS}	-30V
R _{DS(on)} (MAX.)	50mΩ
I _D	-4.5A

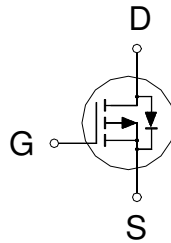

Pb-Free Lead Plating & Halogen Free



ABSOLUTE MAXIMUM RATINGS (T_A = 25 °C Unless Otherwise Noted)

PARAMETERS/TEST CONDITIONS		SYMBOL	LIMITS	UNIT
Gate-Source Voltage		V _{GS}	±20	V
Continuous Drain Current	T _A = 25 °C	I _D	-4.5	A
	T _A = 70 °C		-3.5	
Pulsed Drain Current ¹		I _{DM}	-18	
Power Dissipation	T _A = 25 °C	P _D	1.04	W
	T _A = 70 °C		0.66	
Operating Junction & Storage Temperature Range		T _J , T _{stg}	-55 to 150	°C

THERMAL RESISTANCE RATINGS

THERMAL RESISTANCE	SYMBOL	TYPICAL	MAXIMUM	UNIT
Junction-to-Ambient ³	R _{θJA} (T ≤ 10sec)		83	°C / W
	R _{θJA} (Steady State)		120	

¹Pulse width limited by maximum junction temperature.

²Duty cycle ≤ 1%

³The device mounted on a 1 in² pad of 2 oz copper.

ELECTRICAL CHARACTERISTICS (T_J = 25 °C, Unless Otherwise Noted)

PARAMETER	SYMBOL	TEST CONDITIONS	LIMITS			UNIT
			MIN	TYP	MAX	
STATIC						
Drain-Source Breakdown Voltage	V _{(BR)DSS}	V _{GS} = 0V, I _D = -250μA	-30			V
Gate Threshold Voltage	V _{GS(th)}	V _{DS} = V _{GS} , I _D = -250μA	-1	-1.5	-3	
Gate-Body Leakage	I _{GSS}	V _{DS} = 0V, V _{GS} = ±20V			±100	nA
Zero Gate Voltage Drain Current	I _{DSS}	V _{DS} = -24V, V _{GS} = 0V			-1	μA
		V _{DS} = -20V, V _{GS} = 0V, T _J = 125 °C			-10	
On-State Drain Current ¹	I _{D(ON)}	V _{DS} = -5V, V _{GS} = -10V	-4.5			A
Drain-Source On-State Resistance ¹	R _{DS(ON)}	V _{GS} = -10V, I _D = -4.5A		42	50	mΩ
		V _{GS} = -4.5V, I _D = -3.5A		66	85	
Forward Transconductance ¹	g _{fs}	V _{DS} = -5V, I _D = -4.5A		16		S
DYNAMIC						
Input Capacitance	C _{iss}	V _{GS} = 0V, V _{DS} = -15V, f = 1MHz		820		pF
Output Capacitance	C _{oss}			122		
Reverse Transfer Capacitance	C _{rss}			97		
Total Gate Charge ^{1,2}	Q _g	V _{DS} = -15V, V _{GS} = -10V, I _D = -4.5A		9		nC
Gate-Source Charge ^{1,2}	Q _{gs}			2.2		
Gate-Drain Charge ^{1,2}	Q _{gd}			2.5		
Turn-On Delay Time ^{1,2}	t _{d(on)}	V _{DS} = -15V, I _D = -1A, V _{GS} = -10V, R _{GS} = 6Ω		12		nS
Rise Time ^{1,2}	t _r			16		
Turn-Off Delay Time ^{1,2}	t _{d(off)}			34		
Fall Time ^{1,2}	t _f			20		
SOURCE-DRAIN DIODE RATINGS AND CHARACTERISTICS (T_c = 25 °C)						
Continuous Current	I _S				-3	A
Pulsed Current ³	I _{SM}				-12	
Forward Voltage ¹	V _{SD}	I _F = I _S , V _{GS} = 0V			-1.2	V

¹Pulse test : Pulse Width ≤ 300 μsec, Duty Cycle ≤ 2%.

²Independent of operating temperature.

³Pulse width limited by maximum junction temperature.

EMC will review datasheet by quarter, and update new version.

TYPICAL CHARACTERISTICS

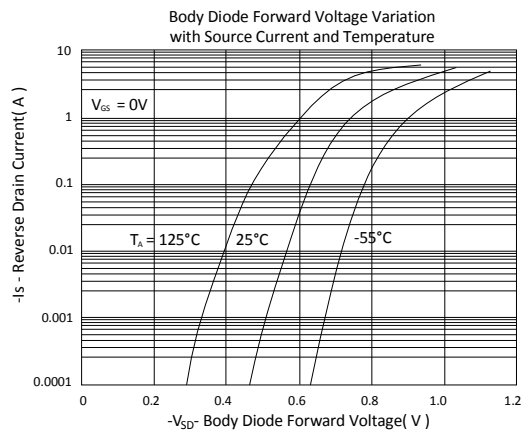
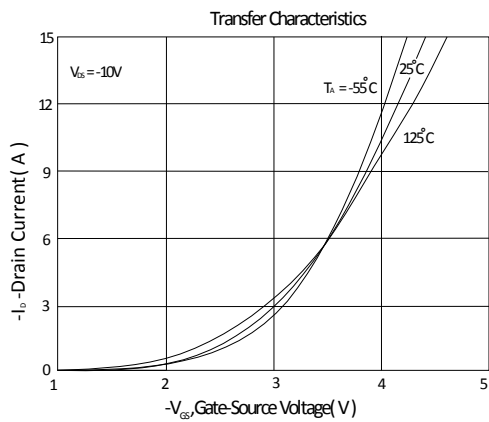
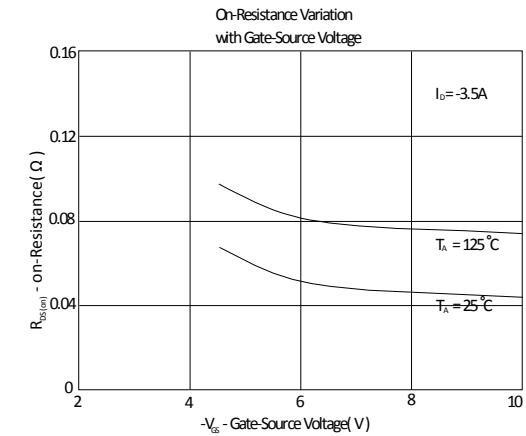
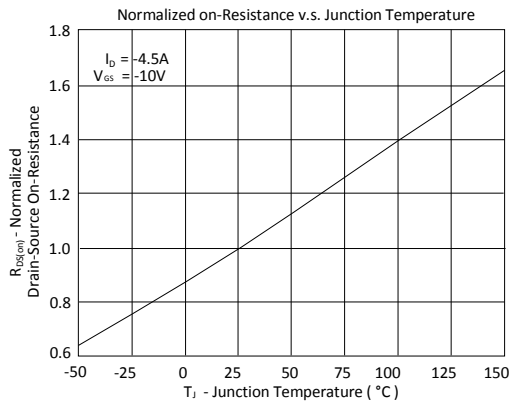
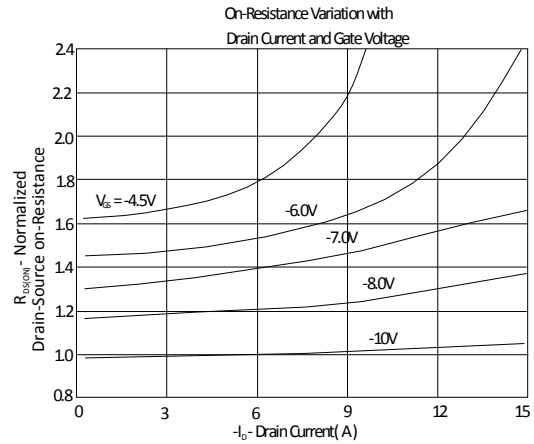
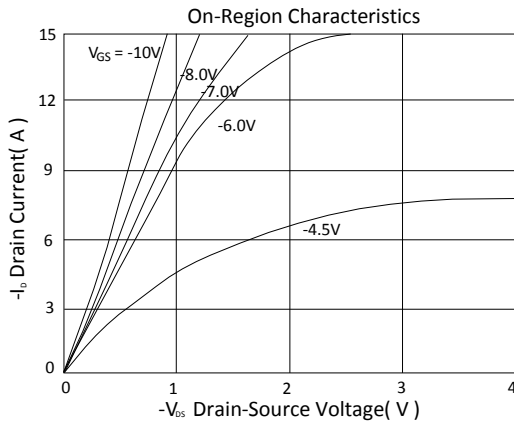

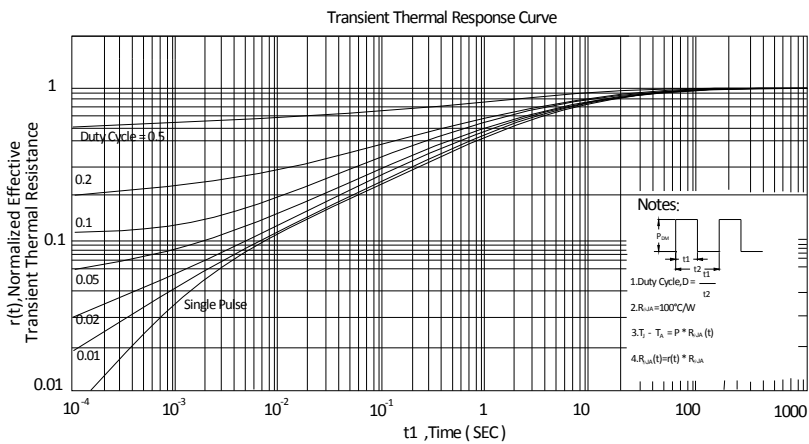
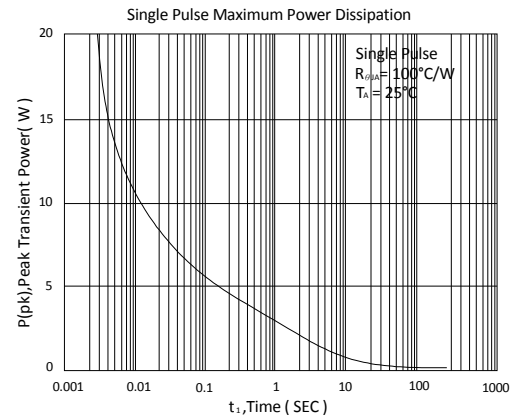
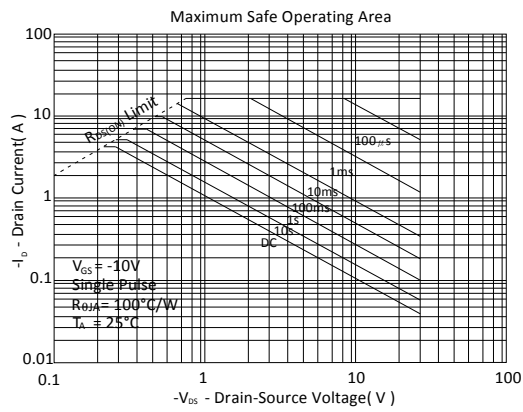
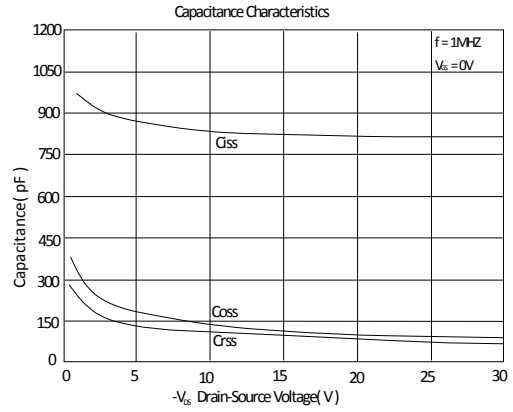
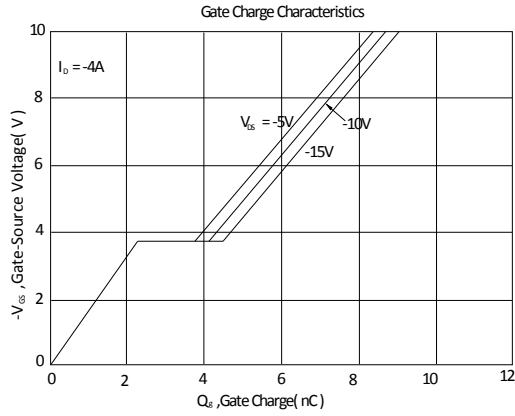

Ordering & Marking Information:

Device Name: EMB50P03JS for SOT23-3

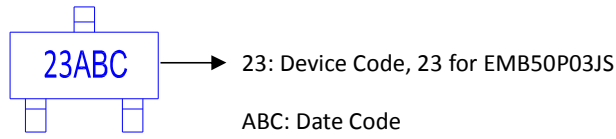

Outline Drawing

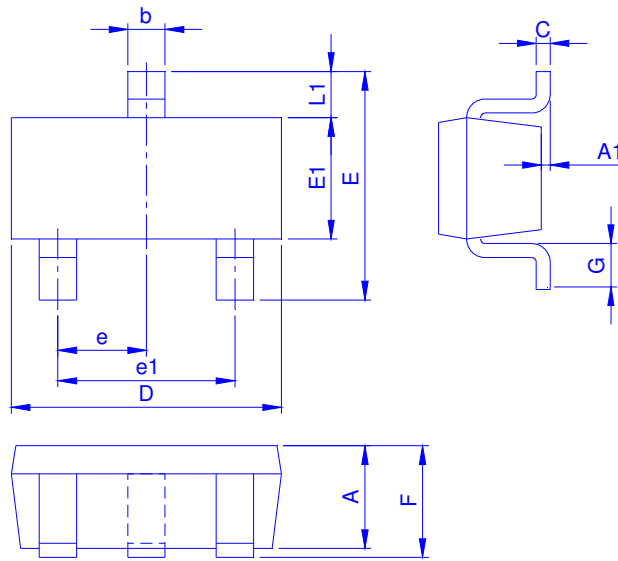

Dimension in mm

Dimension	A	A1	b	C	D	E	E1	e	e1	F	G	L1
Min.	0.70	-	0.30	0.080	2.80	2.10	1.20	0.90	1.80	0.80	0.30	0.54
Typ.	0.95	-	0.40	0.127	2.90	2.50	1.30	0.95	1.90	0.95	0.40	0.57
Max.	1.20	0.15	0.50	0.202	3.10	3.00	1.80	1.00	2.00	1.25	0.60	0.70

Footprint

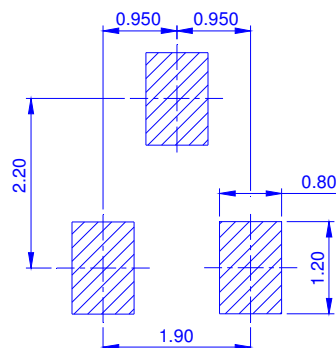



◆ Tape&Reel Information:3000pcs/Reel(Dimension in millimeter)

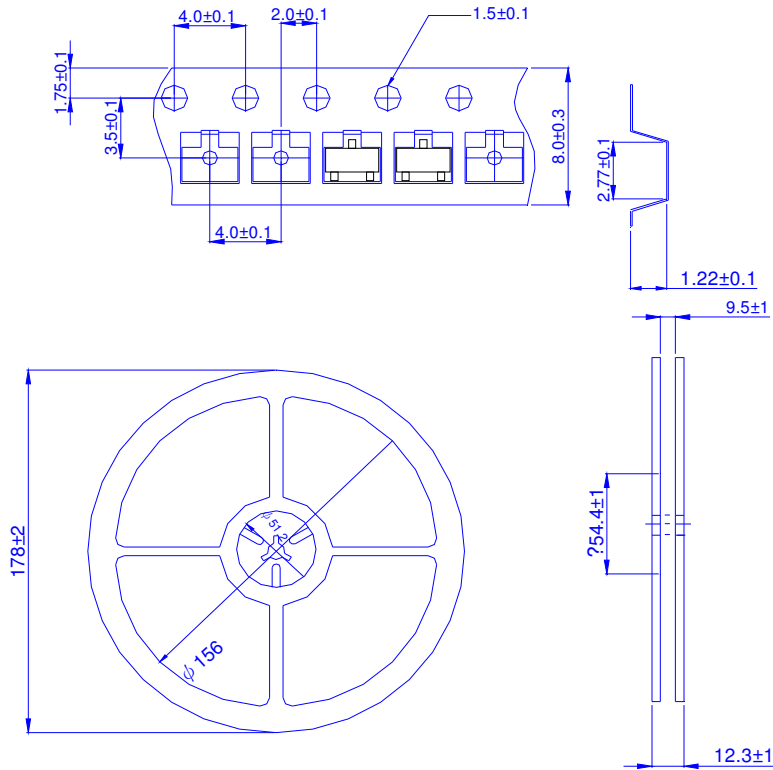

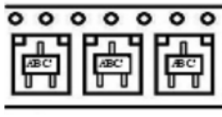
產品別	SOT23-3
Reel 尺寸	7"
編帶方式	FEED DIRECTION 
前空格	50
後空格	50
裝箱數	
滿捲數量	3K
捲/內盒比	5 : 1
內盒滿箱數	15K
內/外箱比	12 : 1