

N-Channel Logic Level Enhancement Mode Field Effect Transistor

Product Summary:

BV _{DSS}	30V
R _{DS(on)} (MAX.)	35mΩ
I _D	5A

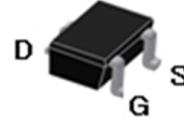
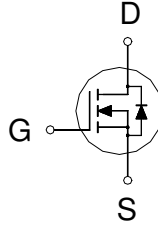

Pb-Free Lead Plating & Halogen Free



ABSOLUTE MAXIMUM RATINGS (T_A = 25 °C Unless Otherwise Noted)

PARAMETERS/TEST CONDITIONS		SYMBOL	LIMITS	UNIT
Gate-Source Voltage		V _{GS}	±20	V
Continuous Drain Current	T _A = 25 °C	I _D	5	A
	T _A = 70 °C		3.3	
Pulsed Drain Current ¹		I _{DM}	20	
Power Dissipation	T _A = 25 °C	P _D	1.25	W
	T _A = 70 °C		0.8	
Operating Junction & Storage Temperature Range		T _J , T _{stg}	-55 to 150	°C

THERMAL RESISTANCE RATINGS

THERMAL RESISTANCE	SYMBOL	TYPICAL	MAXIMUM	UNIT
Junction-to-Ambient ³	R _{θJA}		100	°C / W
Junction-to-Lead ⁴	R _{θJL}		55	

¹Pulse width limited by maximum junction temperature.

²Duty cycle ≤ 1%

³100°C / W when mounted on a 1 in² pad of 2 oz copper.

⁴ R_{θJA} is the sum of the thermal impedance from junction to lead R_{θJL} and lead to ambient.

ELECTRICAL CHARACTERISTICS (T_J = 25 °C, Unless Otherwise Noted)

PARAMETER	SYMBOL	TEST CONDITIONS	LIMITS			UNIT
			MIN	TYP	MAX	
STATIC						
Drain-Source Breakdown Voltage	V _{(BR)DSS}	V _{GS} = 0V, I _D = 250μA	30			V
Gate Threshold Voltage	V _{GS(th)}	V _{DS} = V _{GS} , I _D = 250μA	1.0	1.5	3.0	
Gate-Body Leakage	I _{GSS}	V _{DS} = 0V, V _{GS} = ±20V			±100	nA
Zero Gate Voltage Drain Current	I _{DSS}	V _{DS} = 24V, V _{GS} = 0V			1	μA
		V _{DS} = 20V, V _{GS} = 0V, T _J = 125 °C			10	
On-State Drain Current ¹	I _{D(ON)}	V _{DS} = 5V, V _{GS} = 10V	5			A
Drain-Source On-State Resistance ¹	R _{DS(ON)}	V _{GS} = 10V, I _D = 5A		30	35	mΩ
		V _{GS} = 4.5V, I _D = 4A		40	50	
Forward Transconductance ¹	g _{fs}	V _{DS} = 5V, I _D = 5A		11		S
DYNAMIC						
Input Capacitance	C _{iss}	V _{GS} = 0V, V _{DS} = 10V, f = 1MHz		323		pF
Output Capacitance	C _{oss}			75		
Reverse Transfer Capacitance	C _{rss}			53		
Total Gate Charge ^{1,2}	Q _g	V _{DS} = 10V, V _{GS} = 10V, I _D = 5A		7.1		nC
Gate-Source Charge ^{1,2}	Q _{gs}			1.1		
Gate-Drain Charge ^{1,2}	Q _{gd}			2.2		
Turn-On Delay Time ^{1,2}	t _{d(on)}	V _{DS} = 15V, I _D = 1A, V _{GS} = 10V, R _{GS} = 6Ω		8		nS
Rise Time ^{1,2}	t _r			12		
Turn-Off Delay Time ^{1,2}	t _{d(off)}			28		
Fall Time ^{1,2}	t _f			15		
SOURCE-DRAIN DIODE RATINGS AND CHARACTERISTICS (T_c = 25 °C)						
Continuous Current	I _S				2	A
Pulsed Current ³	I _{SM}				8	
Forward Voltage ¹	V _{SD}	I _F = I _S , V _{GS} = 0V			1.2	V

¹Pulse test : Pulse Width ≤ 300 μsec, Duty Cycle ≤ 2%.

²Independent of operating temperature.

³Pulse width limited by maximum junction temperature.

EMC will review datasheet by quarter, and update new version.

TYPICAL CHARACTERISTICS

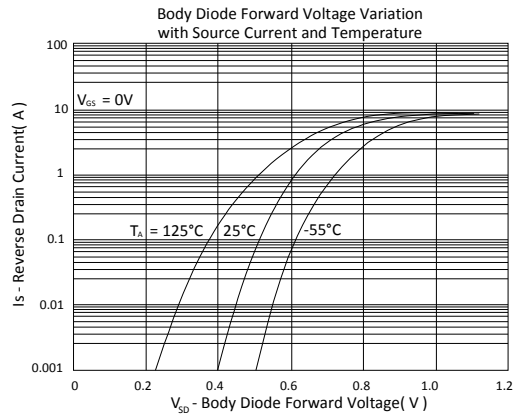
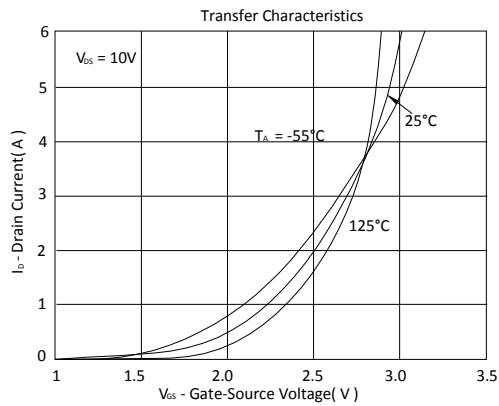
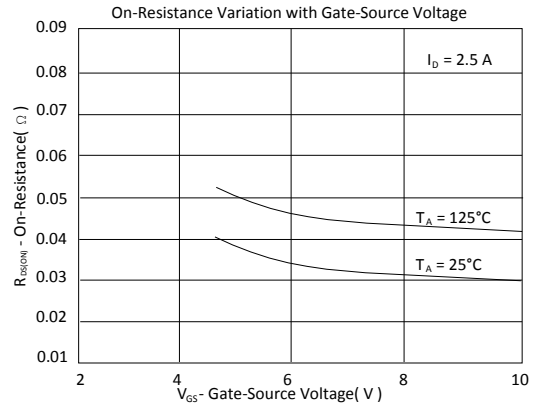
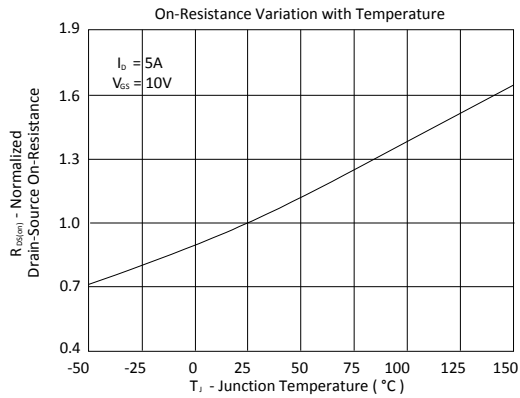
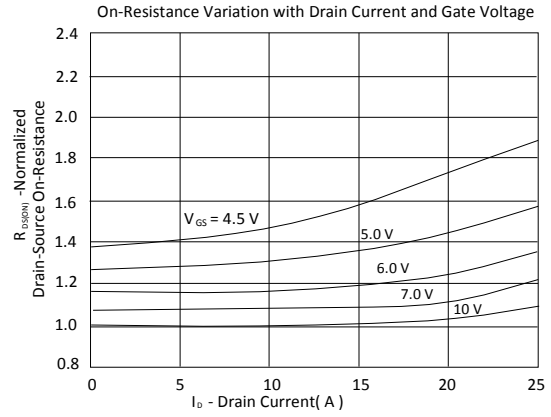
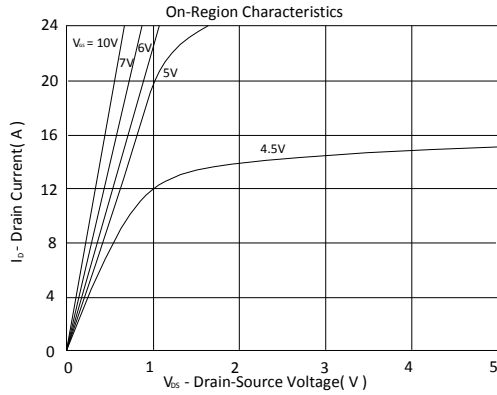

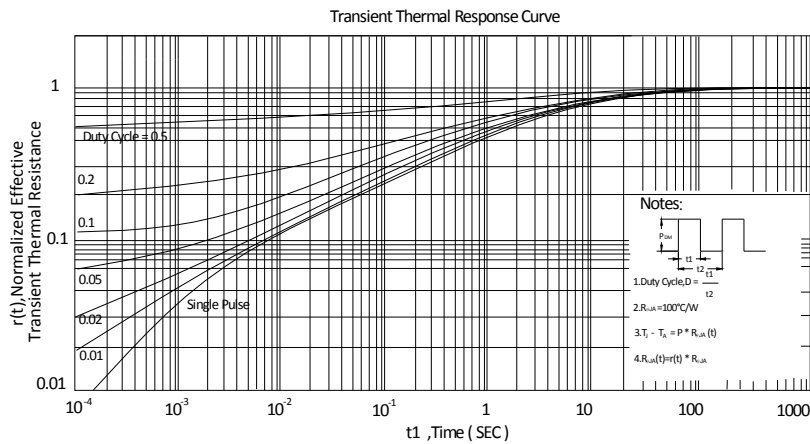
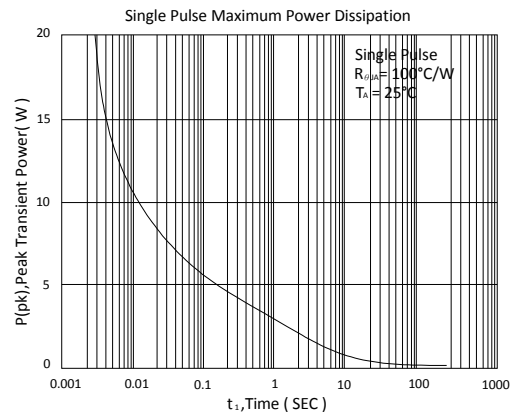
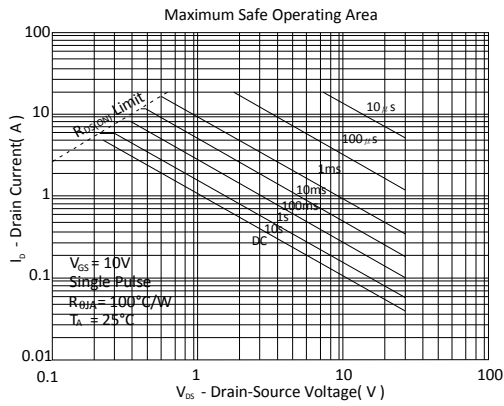
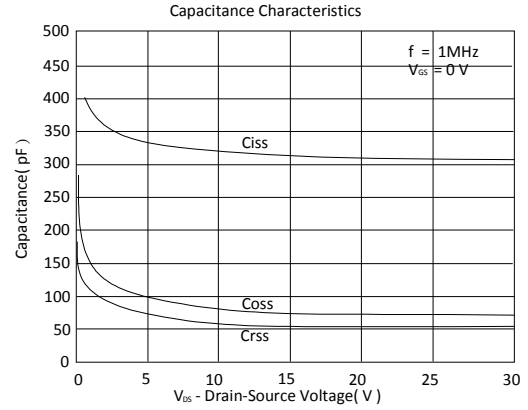
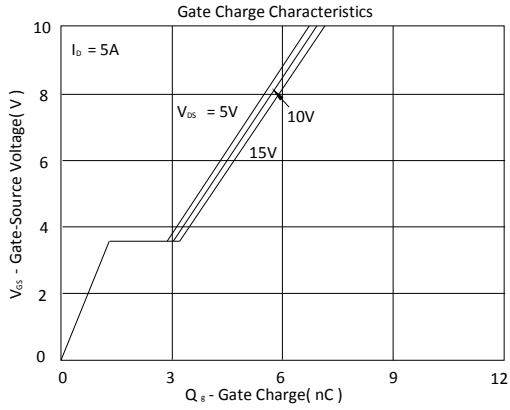

Ordering & Marking Information:

Device Name: EMB32N03J for SOT23-3

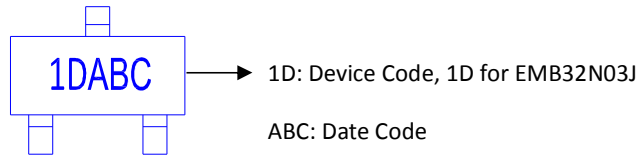

Outline Drawing

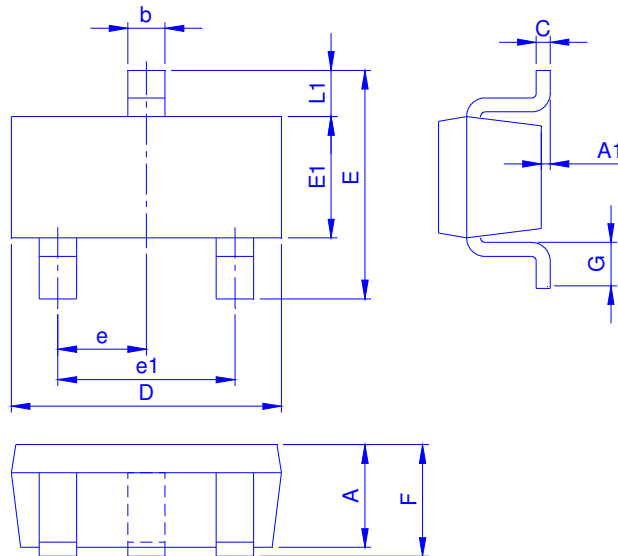

Dimension in mm

Dimension	A	A1	b	C	D	E	E1	e	e1	F	G	L1
Min.	0.70	-	0.30	0.080	2.80	2.10	1.20	0.90	1.80	0.80	0.30	0.54
Typ.	0.95	-	0.40	0.127	2.90	2.50	1.30	0.95	1.90	0.95	0.40	0.57
Max.	1.20	0.15	0.50	0.202	3.10	3.00	1.80	1.00	2.00	1.25	0.60	0.70

Footprint

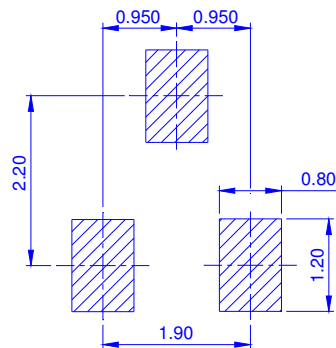

◆ Tape&Reel Information:3000pcs/Reel

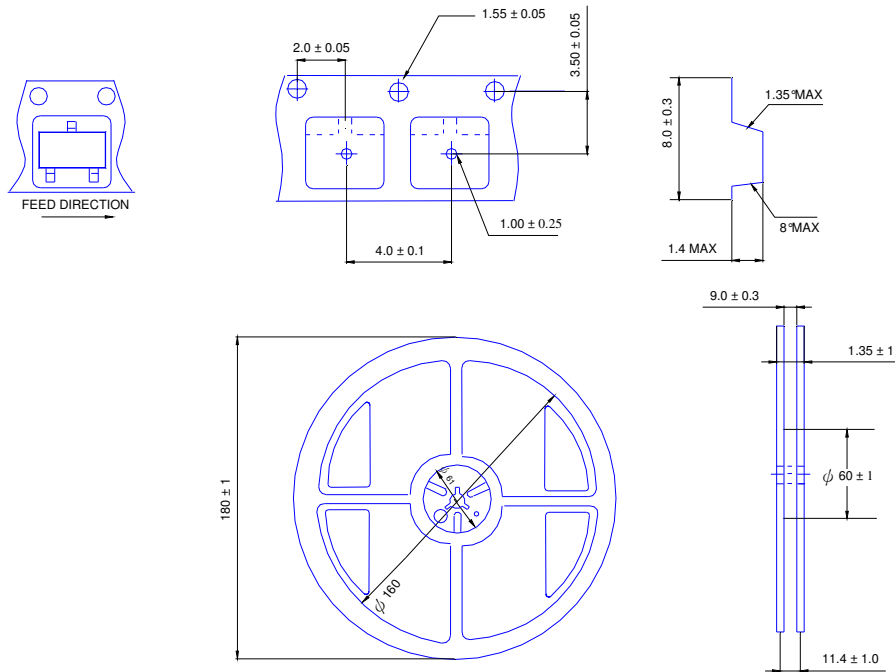

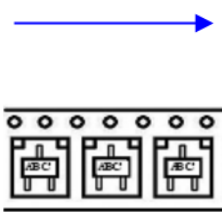
產品別	SOT23-3
Reel 尺寸	7"
編帶方式	FEED DIRECTION 
前空格	50
後空格	50
裝箱數	
滿捲數量	3K
捲/內盒比	5 : 1
內盒滿箱數	15K
內/外箱比	12 : 1
外箱滿箱數	180K