

Dual P-Channel Logic Level Enhancement Mode Field Effect Transistor

Product Summary:

BV_{DSS}	-30V
$R_{DS(on) (MAX.)}$	24m Ω
I_D	-8A

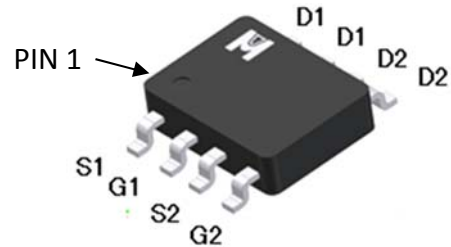
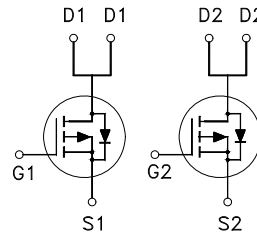

UIS, Rg 100% Tested

Pb-Free Lead Plating



ABSOLUTE MAXIMUM RATINGS ($T_A = 25\text{ }^\circ\text{C}$ Unless Otherwise Noted)

PARAMETERS/TEST CONDITIONS		SYMBOL	LIMITS	UNIT
Gate-Source Voltage		V_{GS}	± 25	V
Continuous Drain Current	$T_C = 25\text{ }^\circ\text{C}$	I_D	-8	A
	$T_C = 100\text{ }^\circ\text{C}$		-6	
Pulsed Drain Current ¹		I_{DM}	-32	
Avalanche Current		I_{AS}	-12	
Avalanche Energy	$L = 0.1\text{mH}, I_D = -8\text{A}, R_G = 25\text{ }\Omega$	E_{AS}	3.2	mJ
Repetitive Avalanche Energy ²	$L = 0.05\text{mH}$	E_{AR}	1.6	
Power Dissipation	$T_A = 25\text{ }^\circ\text{C}$	P_D	2	W
	$T_A = 100\text{ }^\circ\text{C}$		1.1	
Operating Junction & Storage Temperature Range		T_{j}, T_{stg}	-55 to 150	$^\circ\text{C}$

100% UIS testing in condition of $V_D = -15\text{V}, L = 0.1\text{mH}, V_G = -10\text{V}, I_L = -8\text{A}$, Rated $V_{DS} = -30\text{V}$ P-CH

THERMAL RESISTANCE RATINGS

THERMAL RESISTANCE	SYMBOL	TYPICAL	MAXIMUM	UNIT
Junction-to-Case	$R_{\theta JC}$		25	$^\circ\text{C} / \text{W}$
Junction-to-Ambient ³	$R_{\theta JA}$		62.5	

¹Pulse width limited by maximum junction temperature.

²Duty cycle $\leq 1\%$

³62.5 $^\circ\text{C} / \text{W}$ when mounted on a 1 in² pad of 2 oz copper.



ELECTRICAL CHARACTERISTICS ($T_A = 25\text{ }^\circ\text{C}$, Unless Otherwise Noted)

PARAMETER	SYMBOL	TEST CONDITIONS	LIMITS			UNIT
			MIN	TYP	MAX	
STATIC						
Drain-Source Breakdown Voltage	$V_{(BR)DSS}$	$V_{GS} = 0V, I_D = -250\mu A$	-30			V
Gate Threshold Voltage	$V_{GS(th)}$	$V_{DS} = V_{GS}, I_D = -250\mu A$	-1	-1.5	-3	
Gate-Body Leakage	I_{GSS}	$V_{DS} = 0V, V_{GS} = \pm 20V$			± 100	nA
		$V_{DS} = 0V, V_{GS} = \pm 25V$			± 500	
Zero Gate Voltage Drain Current	I_{DSS}	$V_{DS} = -24V, V_{GS} = 0V$			-1	μA
		$V_{DS} = -20V, V_{GS} = 0V, T_J = 125\text{ }^\circ\text{C}$			-10	
On-State Drain Current ¹	$I_{D(ON)}$	$V_{DS} = -5V, V_{GS} = -10V$	-8			A
Drain-Source On-State Resistance ¹	$R_{DS(ON)}$	$V_{GS} = -10V, I_D = -8A$		20.5	24	m Ω
		$V_{GS} = -4.5V, I_D = -6A$		29	37	
Forward Transconductance ¹	g_{fs}	$V_{DS} = -5V, I_D = -8A$		24		S
DYNAMIC						
Input Capacitance	C_{iss}	$V_{GS} = 0V, V_{DS} = -15V, f = 1MHz$		1407		pF
Output Capacitance	C_{oss}			208		
Reverse Transfer Capacitance	C_{rss}			164		
Gate Resistance	R_g	$V_{GS} = 15mV, V_{DS} = 0V, f = 1MHz$		4.5		Ω
Total Gate Charge ^{1,2}	$Q_g(V_{GS}=10V)$	$V_{DS} = -15V, V_{GS} = -10V,$ $I_D = -8A$		20.3		nC
	$Q_g(V_{GS}=4.5V)$			9.8		
Gate-Source Charge ^{1,2}	Q_{gs}			3.2		
Gate-Drain Charge ^{1,2}	Q_{gd}			4.9		
Turn-On Delay Time ^{1,2}	$t_{d(on)}$		$V_{DS} = -15V,$ $I_D = -1A, V_{GS} = -10V, R_{GS} = 2.7\Omega$		10	
Rise Time ^{1,2}	t_r			8		
Turn-Off Delay Time ^{1,2}	$t_{d(off)}$			25		
Fall Time ^{1,2}	t_f			6		
SOURCE-DRAIN DIODE RATINGS AND CHARACTERISTICS ($T_C = 25\text{ }^\circ\text{C}$)						
Continuous Current	I_S				-2.3	A
Pulsed Current ³	I_{SM}				-9.2	
Forward Voltage ¹	V_{SD}	$I_F = I_S, V_{GS} = 0V$			-1.2	V
Reverse Recovery Time	t_{rr}	$I_F = I_S, di_F/dt = 100A / \mu S$		32		nS
Reverse Recovery Charge	Q_{rr}			26		nC

¹Pulse test : Pulse Width $\leq 300 \mu\text{sec}$, Duty Cycle $\leq 2\%$.

²Independent of operating temperature.

³Pulse width limited by maximum junction temperature.

EMC will review datasheet by quarter, and update new version.



TYPICAL CHARACTERISTICS

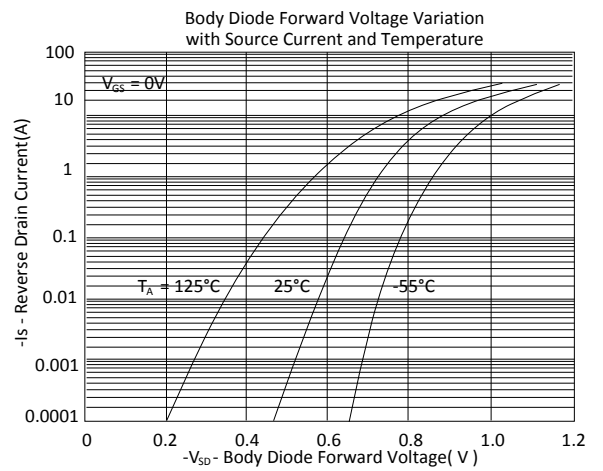
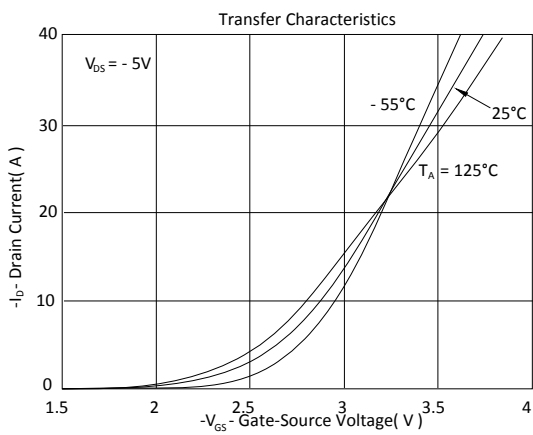
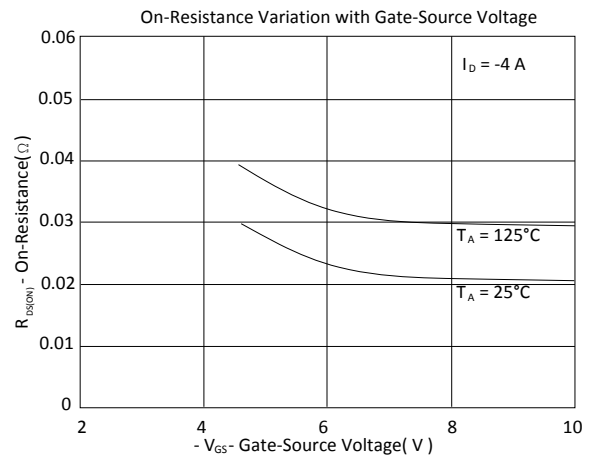
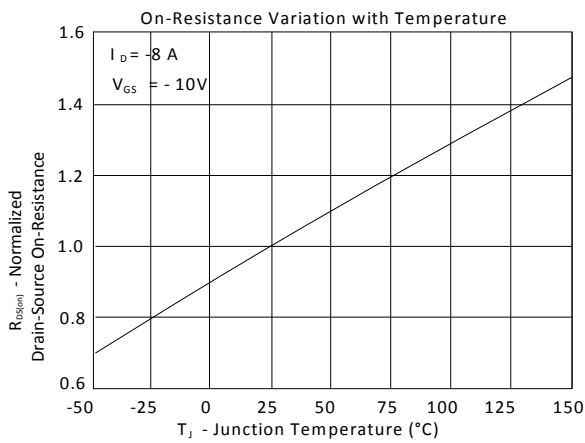
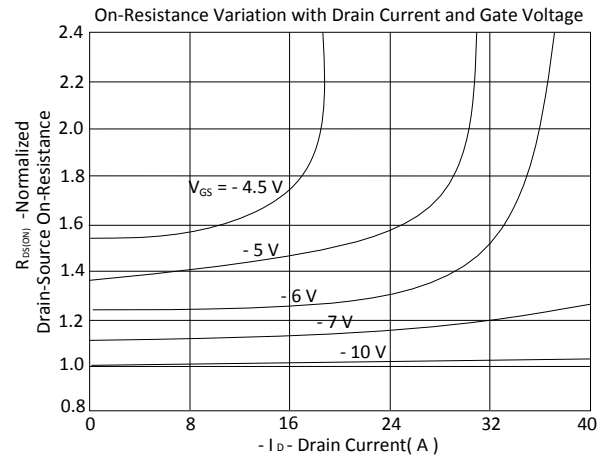
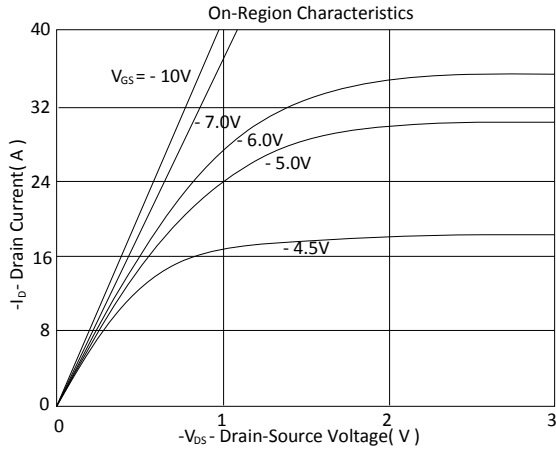

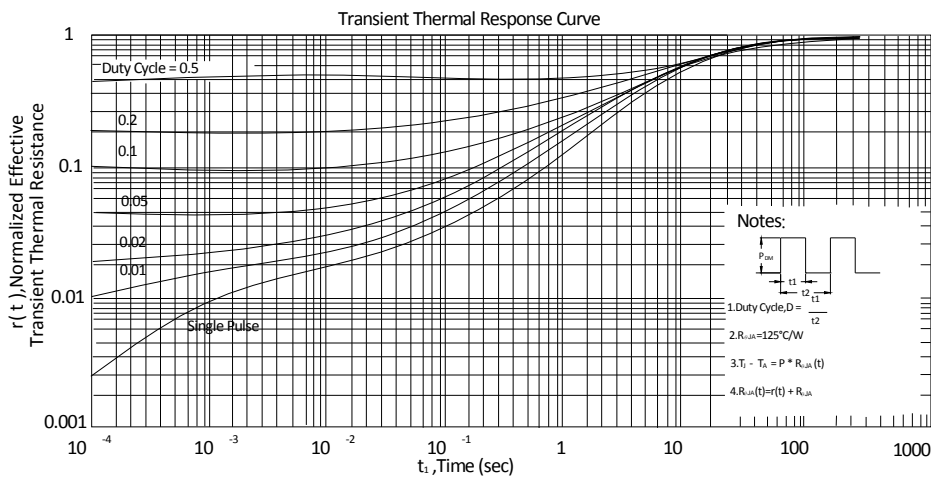
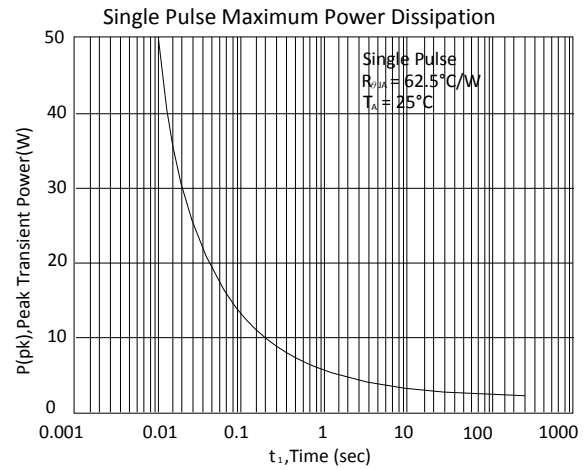
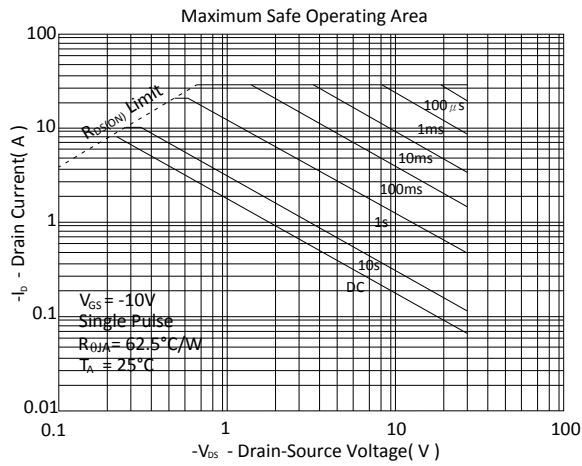
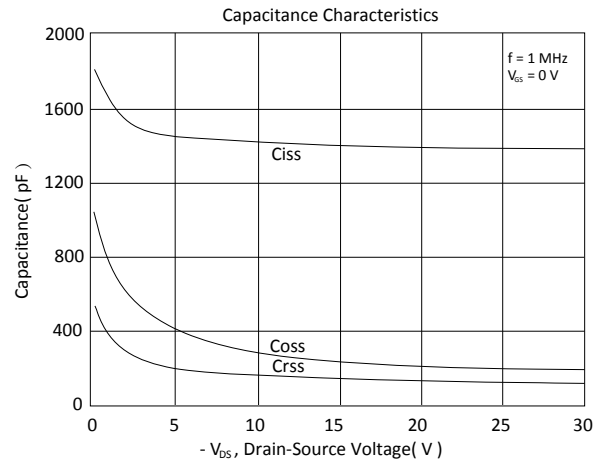
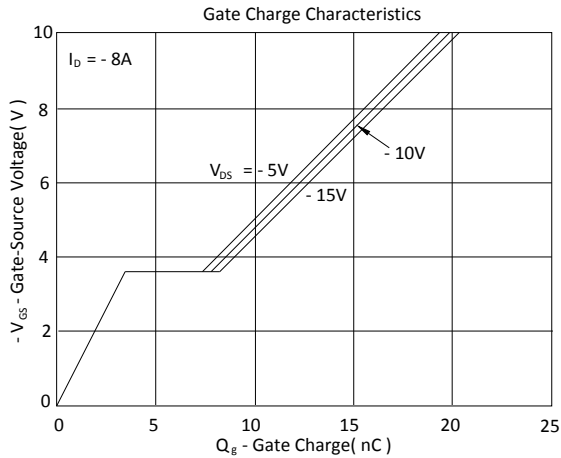

Ordering & Marking Information:

Device Name: EMB24B03G for SOP-8

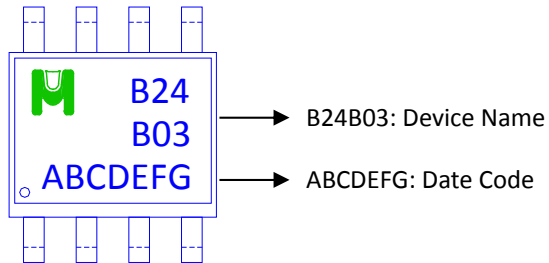

Outline Drawing

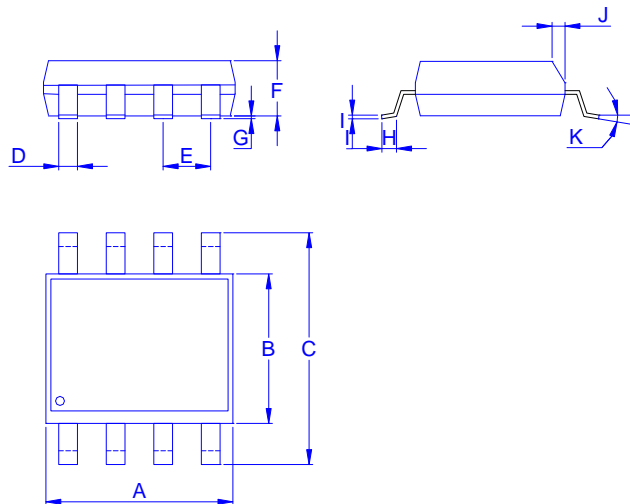

Dimension in mm

Dimension	A	B	C	D	E	F	G	H	I	J	K
Min.	4.70	3.80	5.80	0.31		1.35	0.01	0.40	0.10	0.25	0°
Typ.	4.90	3.90	6.00	0.41	1.27	1.55	0.18	0.60	0.20	0.30	
Max.	5.10	4.00	6.20	0.51		1.75	0.25	1.27	0.25	0.50	8°

Footprint

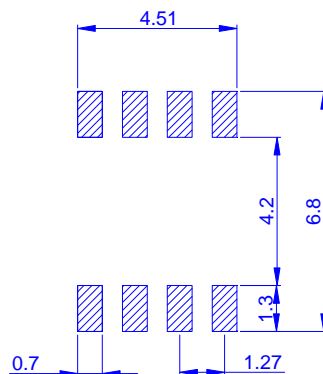



Tape&Reel Information:2500pcs/Reel

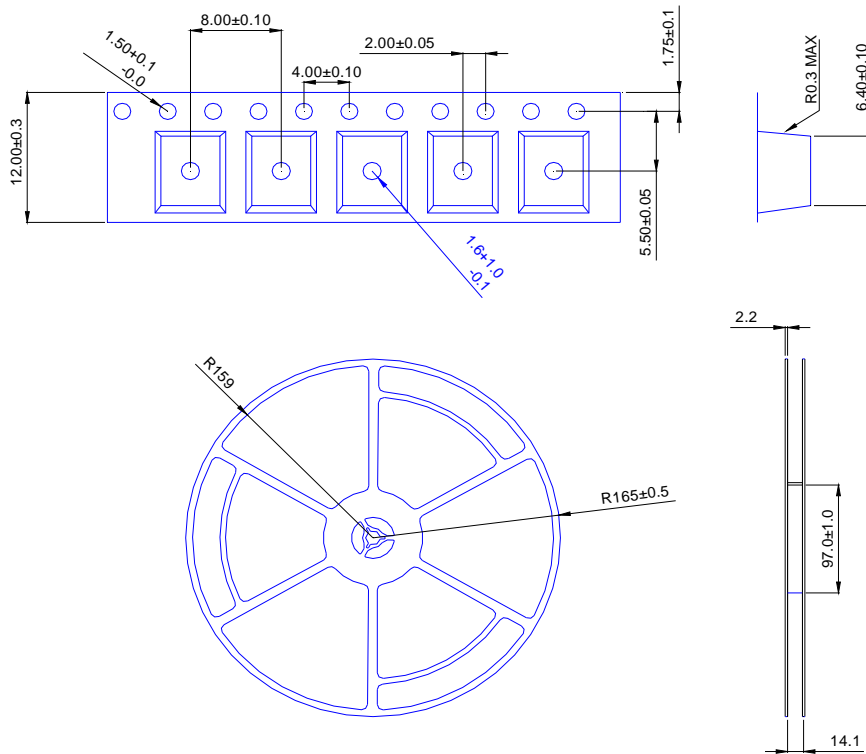

產品別	SOP-8
Reel 尺寸	13"
編帶方式	FEED DIRECTION 
前空格	25
後空格	50
裝箱數	
滿捲數量	2.5K
捲/內盒比	1 : 1
內盒滿箱數	2.5K
內/外箱比	10 : 1
外箱滿箱數	25K