

N-Channel Logic Level Enhancement Mode Field Effect Transistor

Product Summary:

BV _{DSS}	60V
R _{DS(on)} (MAX.)	8.0mΩ
I _D	40A

N Channel MOSFET

UIS, R_g 100% Tested

Pb-Free Lead Plating & Halogen Free

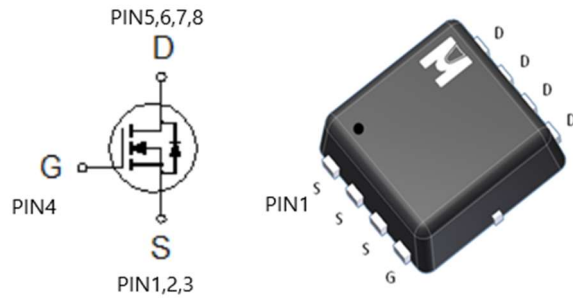

ABSOLUTE MAXIMUM RATINGS (T_A = 25 °C Unless Otherwise Noted)

PARAMETERS/TEST CONDITIONS		SYMBOL	LIMITS	UNIT
Gate-Source Voltage		V _{GS}	±20	V
Continuous Drain Current ¹	T _C = 25 °C	I _D	40	A
	T _A = 25 °C		14	
	T _A = 70 °C		11	
Pulsed Drain Current ²		I _{DM}	120	
Avalanche Current		I _{AS}	20	
Avalanche Energy	L = 0.1mH, I _{AS} =20A, R _G =25Ω	E _{AS}	20	mJ
Repetitive Avalanche Energy ³	L = 0.05mH	E _{AR}	10	
Power Dissipation	T _C = 25 °C	P _D	21	W
	T _C = 100 °C		83	
Power Dissipation	T _A = 25 °C	P _D	2.5	W
	T _A = 100 °C		1	
Operating Junction & Storage Temperature Range		T _J , T _{stg}	-55 to 150	°C

THERMAL RESISTANCE RATINGS

THERMAL RESISTANCE	SYMBOL	TYPICAL	MAXIMUM	UNIT
Junction-to-Case	R _{θJC}		6	°C / W
Junction-to-Ambient	R _{θJA}		50	

¹Package limited.

²Pulse width limited by maximum junction temperature.

³Duty cycle ≤ 1%



ELECTRICAL CHARACTERISTICS (T_J = 25 °C, Unless Otherwise Noted)

PARAMETER	SYMBOL	TEST CONDITIONS	LIMITS			UNIT
			MIN	TYP	MAX	
STATIC						
Drain-Source Breakdown Voltage	V _{(BR)DSS}	V _{GS} = 0V, I _D = 250μA	60			V
Gate Threshold Voltage	V _{GS(th)}	V _{DS} = V _{GS} , I _D = 250μA	1.0	2.0	3.0	
Gate-Body Leakage	I _{GSS}	V _{DS} = 0V, V _{GS} = ±20V			±100	nA
Zero Gate Voltage Drain Current	I _{DSS}	V _{DS} = 48V, V _{GS} = 0V			1	μA
		V _{DS} = 40V, V _{GS} = 0V, T _J = 125 °C			25	
On-State Drain Current ¹	I _{D(ON)}	V _{DS} = 5V, V _{GS} = 10V	30			A
Drain-Source On-State Resistance ¹	R _{DS(ON)}	V _{GS} = 10V, I _D = 20A		6.9	8.0	mΩ
		V _{GS} = 4.5V, I _D = 16A		9.7	12.0	
Forward Transconductance ¹	g _{fs}	V _{DS} = 5V, I _D = 14A		26		S
DYNAMIC						
Input Capacitance	C _{iss}	V _{GS} = 0V, V _{DS} = 30V, f = 1MHz		1168		pF
Output Capacitance	C _{oss}			472		
Reverse Transfer Capacitance	C _{rss}			19		
Gate Resistance	R _g	V _{GS} = 15mV, V _{DS} = 0V, f = 1MHz		2.2		Ω
Total Gate Charge ^{1,2}	Q _g	V _{DS} = 30V, V _{GS} = 10V, I _D = 20A		16		nC
Gate-Source Charge ^{1,2}	Q _{gs}			5.5		
Gate-Drain Charge ^{1,2}	Q _{gd}			1.2		
Turn-On Delay Time ^{1,2}	t _{d(on)}	V _{DS} = 30V, I _D = 14A, V _{GS} = 10V, R _{GS} = 6Ω		8		nS
Rise Time ^{1,2}	t _r			3		
Turn-Off Delay Time ^{1,2}	t _{d(off)}			25		
Fall Time ^{1,2}	t _f			3		
SOURCE-DRAIN DIODE RATINGS AND CHARACTERISTICS (T_C = 25 °C)						
Continuous Current	I _S				30	A
Pulsed Current ³	I _{SM}				120	
Forward Voltage ¹	V _{SD}	I _F = 20A, V _{GS} = 0V			1.3	V
Reverse Recovery Time	t _{rr}	I _F = 14A, dI _F /dt = 100A / μS		30		nS
Reverse Recovery Charge	Q _{rr}				43	

¹Pulse test : Pulse Width ≤ 300 μsec, Duty Cycle ≤ 2%.

²Independent of operating temperature.

³Pulse width limited by maximum junction temperature.

EMC will review datasheet by quarter, and update new version.

TYPICAL CHARACTERISTICS

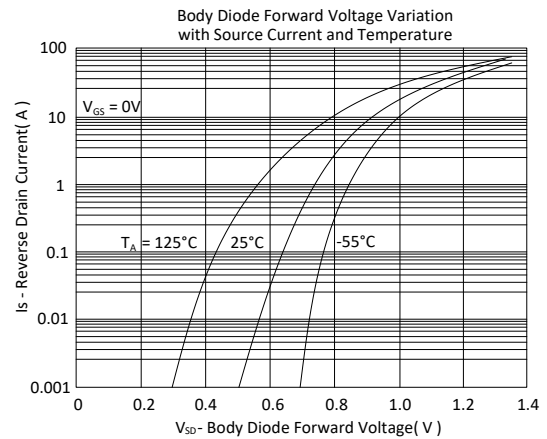
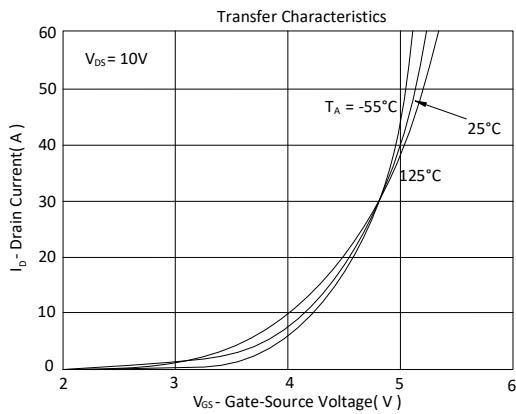
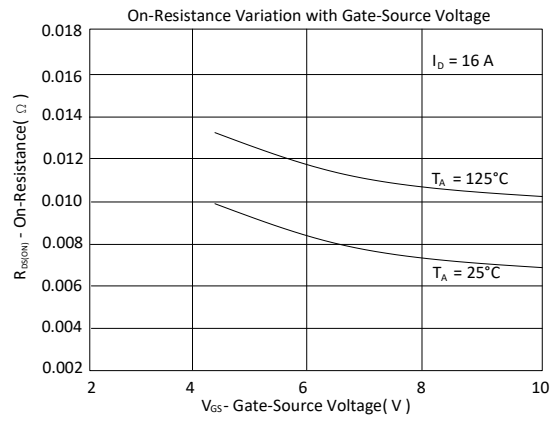
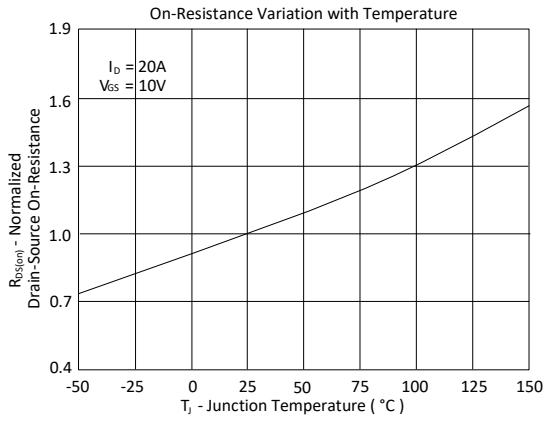
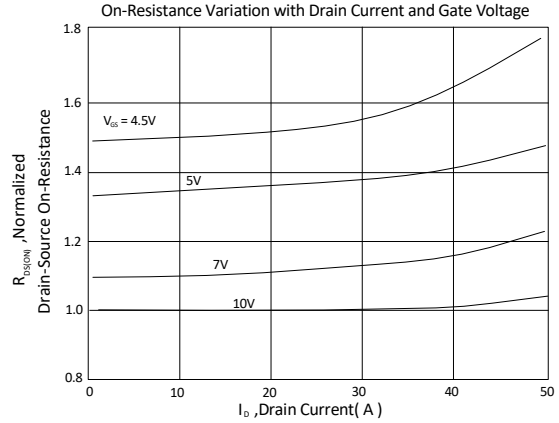
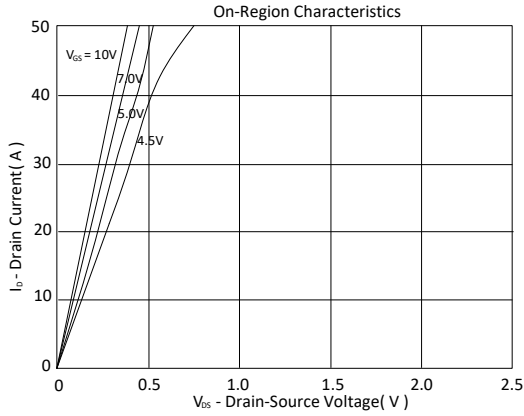

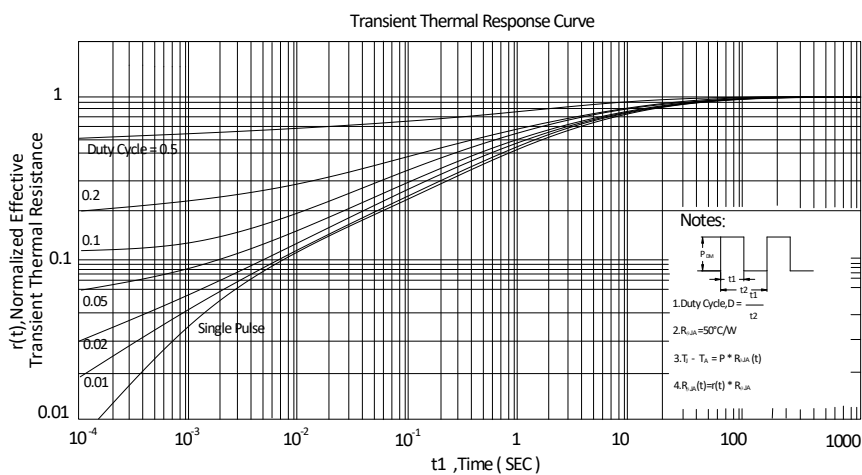
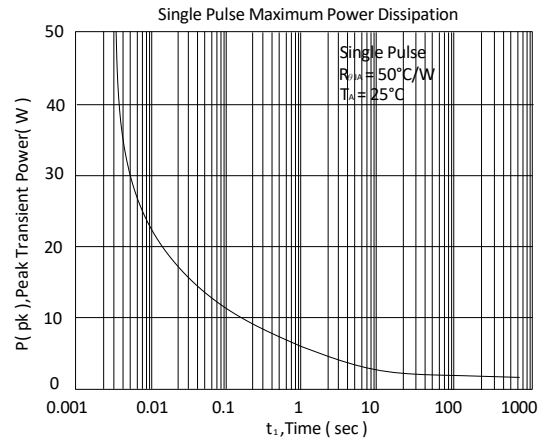
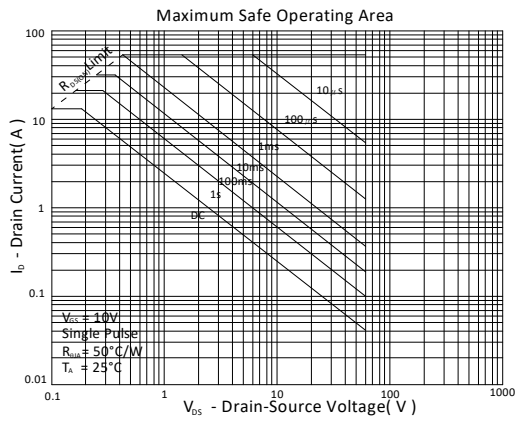
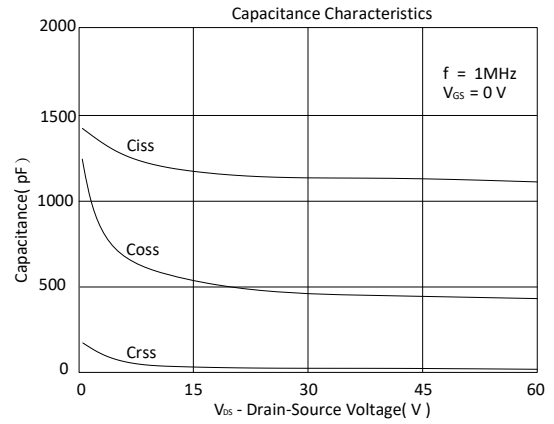
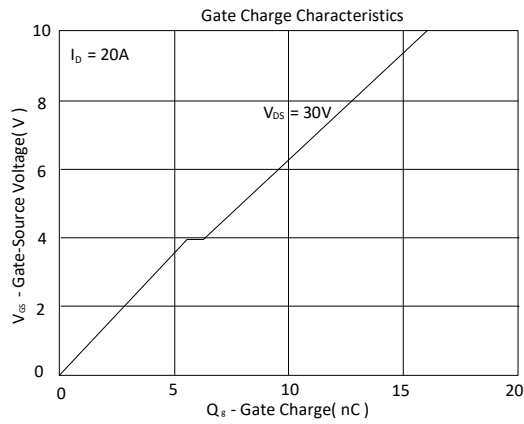

Ordering & Marking Information:

Device Name: EMB08N06VS for EDFN 3 x 3



B08N06S: Device Name

ABCDEFGH: Date Code

A: Assembly House

B: Year(A:2008 B:2009 C:2010....)

C: Month(A:01 B:02 C:03 D:04 E:05 F:06 G:07 H:08 I:09 J:10 K:11 L:12)

DEFG: Serial No.

Outline Drawing

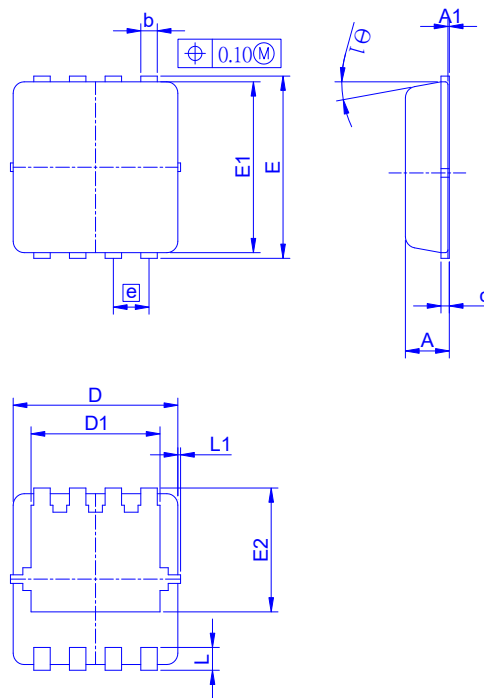

Dimension in mm

Dimension	A	A1	b	c	D	D1	E	E1	E2	e	L	L1	θ
Min.	0.65	0	0.20	0.10	2.90	2.15	3.10	2.90	1.53	0.55	0.25	-	0°
Typ.	0.75	-	0.30	0.15	3.00	2.45	3.20	3.00	1.97	0.65	0.40	0.075	10°
Max.	0.90	0.05	0.40	0.25	3.30	2.74	3.50	3.30	2.59	0.75	0.60	0.150	14°

Recommended minimum pads

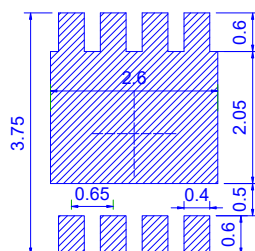



Tape&Reel Information: 5000pcs/Reel

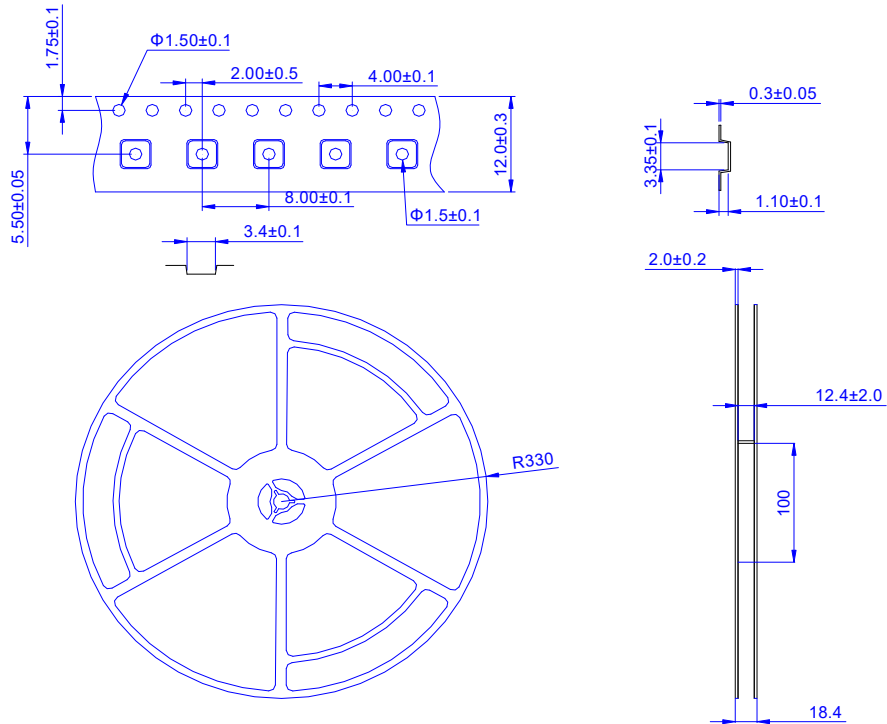

產品別	EDFN3X3
Reel 尺寸	13"
編帶方式	<p>FEEED DIRECTION</p>
前空格	50
後空格	50
裝箱數	
滿捲數量	5K
捲/內盒比	1 : 1
內盒滿箱數	5K
內/外箱比	10 : 1
外箱滿箱數	50K