

Single N-Channel Logic Level Enhancement Mode Field Effect Transistor

•Product Summary:

	N-CH
BVDSS	100V
$R_{DS(on) (MAX.)}@V_{GS}=10V$	5.5mΩ
$R_{DS(on) (MAX.)}@V_{GS}=4.5V$	7.5mΩ
$I_D @T_C=25^{\circ}C$	122.0A
$I_D @T_A=25^{\circ}C$	16.0A

• Pin Description:

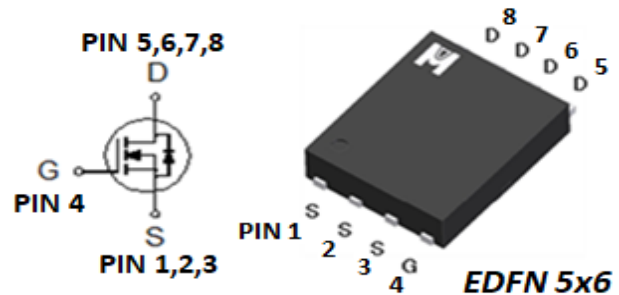

Single N Channel MOSFET

UIS, Rg 100% Tested

Pb-Free Lead Plating & Halogen Free

•ABSOLUTE MAXIMUM RATINGS ($T_C = 25^{\circ}C$ Unless Otherwise Noted)



PARAMETERS/TEST CONDITIONS	SYMBOL	LIMITS	UNIT
Gate-Source Voltage	V_{GS}	± 20	V
Continuous Drain Current	I_D	$T_C = 25^{\circ}C$	122
		$T_C = 100^{\circ}C$	77
Continuous Drain Current	I_D	$T_A = 25^{\circ}C$	16
		$T_A = 70^{\circ}C$	13
Pulsed Drain Current ¹	I_{DM}	196	A
Avalanche Current	I_{AS}	36	
Avalanche Energy	E_{AS}	64.8	mJ
Repetitive Avalanche Energy ²	E_{AR}	32.4	
Power Dissipation	P_D	$T_C = 25^{\circ}C$	138.9
		$T_C = 100^{\circ}C$	55.6
Power Dissipation	P_D	$T_A = 25^{\circ}C$	2.5
		$T_A = 70^{\circ}C$	1.6
Operating Junction & Storage Temperature Range	T_j, T_{stg}	-55 to 150	$^{\circ}C$

• 100% UIS testing in condition of $V_D=15V, L=0.1mH, V_G=10V, I_L=22A$, Rated $V_{DS}=30V$ N-CH

•THERMAL RESISTANCE RATINGS

THERMAL RESISTANCE	SYMBOL	TYPICAL	MAXIMUM	UNIT
Junction-to-Case	$R_{\theta JC}$		0.9	$^{\circ}C/W$
Junction-to-Ambient ³	$R_{\theta JA}$		50	

¹Pulse width limited by maximum junction temperature.

²Duty cycle $< 1\%$

³50 $^{\circ}C$ / W when mounted on a 1 in² pad of 2 oz copper.

⁴Guarantee by Engineering test

•ELECTRICAL CHARACTERISTICS (T_J = 25 °C, Unless Otherwise Noted)

PARAMETER	SYMBOL	TEST CONDITIONS	LIMITS			UNIT
			MIN	TYP	MAX	
STATIC						
Drain-Source Breakdown Voltage ⁴	V _{(BR)DSS}	V _{GS} = 0V, I _D = 250uA	100			V
Gate Threshold Voltage ⁴	V _{GS(th)}	V _{DS} = V _{GS} , I _D = 250uA	1.5	2	2.5	
Gate-Body Leakage ⁴	I _{GSS}	V _{DS} = 0V, V _{GS} = ±20V			±100	nA
Zero Gate Voltage Drain Current ⁴	I _{DSS}	V _{DS} = 30V, V _{GS} = 0V			1	uA
		V _{DS} = 30V, V _{GS} = 0V, T _J = 125 °C			25	
On-State Drain Current ¹	I _{D(ON)}	V _{DS} = 10V, V _{GS} = 10V	122			A
Drain-Source On-State Resistance ^{1,4}	R _{DS(ON)}	V _{GS} = 10V, I _D = 20A		4.8	5.5	mΩ
		V _{GS} = 4.5V, I _D = 20A		5.7	7.5	
Forward Transconductance ¹	g _{fs}	V _{DS} = 5V, I _D = 20A		25		S
DYNAMIC						
Input Capacitance ⁵	C _{iss}	V _{GS} = 0V, V _{DS} = 50V, f = 1MHz		3421		pF
Output Capacitance ⁵	C _{oss}			620		
Reverse Transfer Capacitance ⁵	C _{rss}			30		
Gate Resistance ^{4,5}	R _g	f = 1MHz		0.7		Ω
Total Gate Charge ^{1,2,5}	Q _g (V _{GS} =10V)	V _{DS} = 50V, V _{GS} = 10V, I _D = 20A		52.4		nC
	Q _g (V _{GS} =4.5V)			28.1		
Gate-Source Charge ^{1,2,5}	Q _{gs}			9.4		
Gate-Drain Charge ^{1,2,5}	Q _{gd}			11.5		
Turn-On Delay Time ^{1,2,5}	t _{d(on)}	V _{DS} = 50V, V _{GS} = 10V, I _D = 5A, R _g = 6Ω		11.5		nS
Rise Time ^{1,2,5}	t _r			7.2		
Turn-Off Delay Time ^{1,2,5}	t _{d(off)}			27.0		
Fall Time ^{1,2,5}	t _f			36.3		
SOURCE-DRAIN DIODE RATINGS AND CHARACTERISTICS						
Continuous Current	I _S				122	A
Pulsed Current ³	I _{SM}				196	
Forward Voltage ^{1,4}	V _{SD}	I _F = 30A, V _{GS} = 0V			1.2	V
Reverse Recovery Time ⁵	t _{rr}	I _F = 30A, dI _F /dt = 100A / uS		66.1		nS
Peak Reverse Recovery Current ⁵	I _{RM(REC)}			2.39		A
Reverse Recovery Charge ⁵	Q _{rr}			89.3		nC

¹ Pulse test : Pulse Width ≤ 300 usec, Duty Cycle ≤ 2%.

² Independent of operating temperature.

³ Pulse width limited by maximum junction temperature.

⁴ Guarantee by FT test Item

⁵ Guarantee by Engineering test

EMC will review datasheet by quarter, and update new version.

▪ TYPICAL CHARACTERISTICS

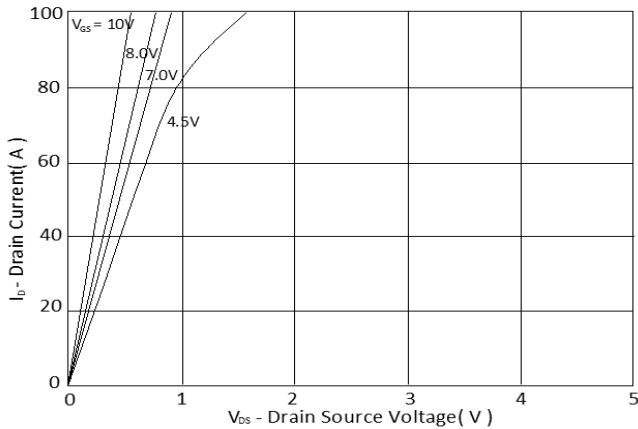

Fig.1 Typical Output Characteristics

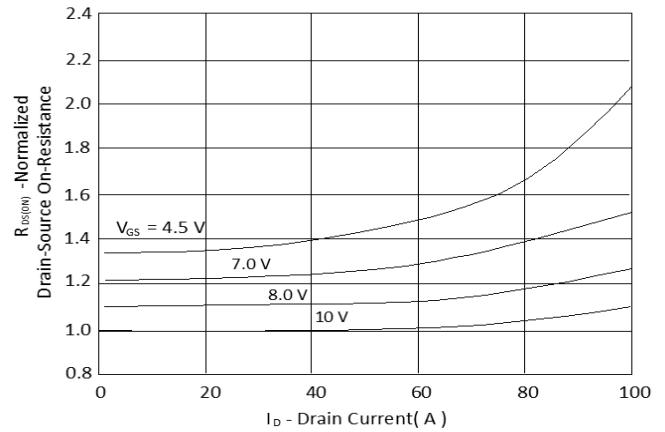

Fig.2 On-Resistance Variation with Drain Current and Gate Voltage

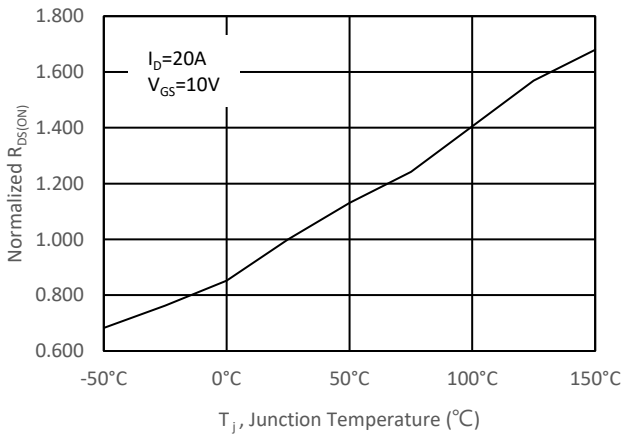

Fig.3 Normalized On-Resistance v.s. Junction Temperature

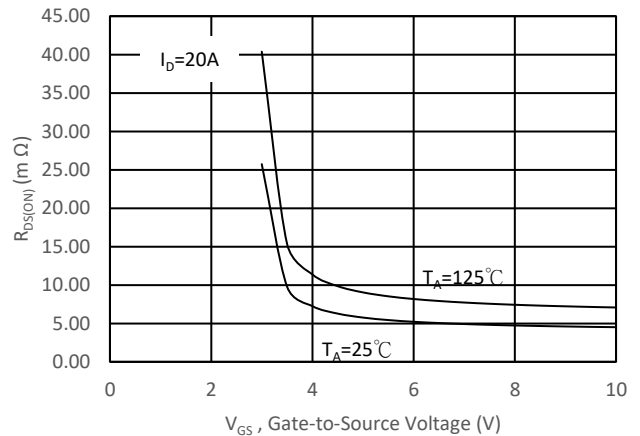

Fig.4 On-Resistance v.s. Gate Voltage

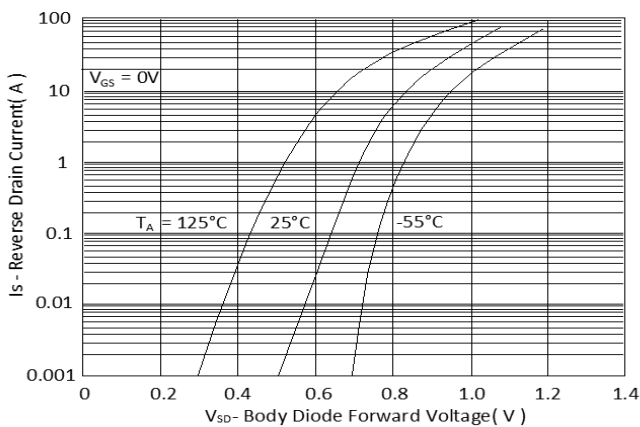

Fig.5 Forward Characteristic of Reverse Diode

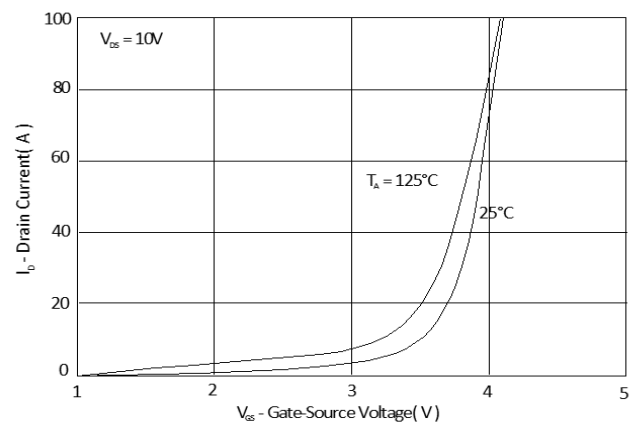

Fig.6 Transfer Characteristics

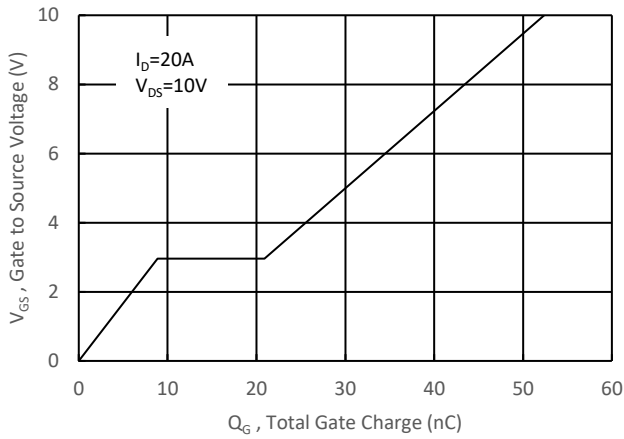

Fig.7 Gate Charge Characteristics

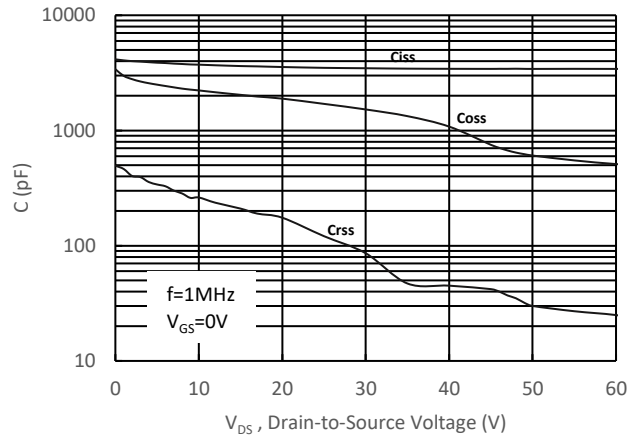

Fig.8 Typical Capacitance Characteristics

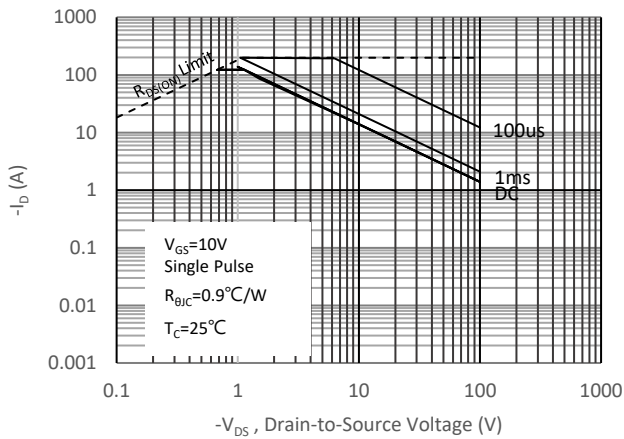

Fig 9. Maximum Safe Operating Area

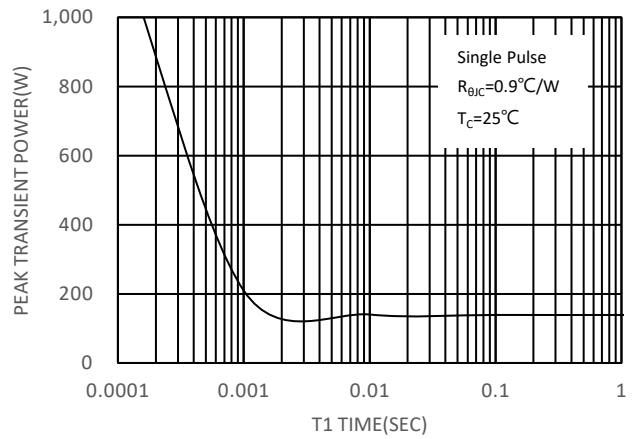

Fig 10. Single Pulse Maximum Power Dissipation

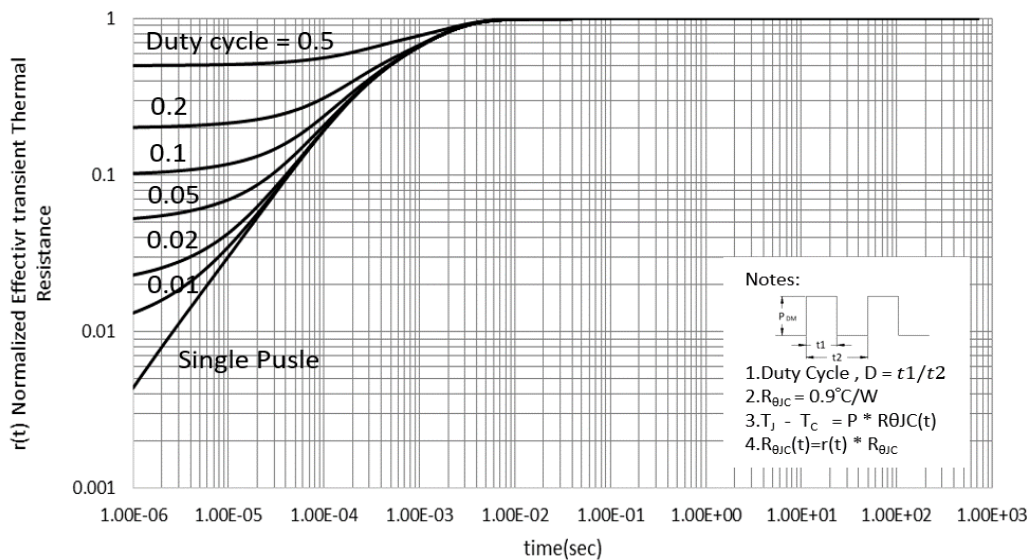

Fig 11. Effective Transient Thermal Impedance

Ordering & Marking Information:

Device Name: EMB05N10HS for EDFN 5x6



B05N10S: Device Name

ABCDEFGH: Date Code

A: Assembly House

B: Year(A:2008 B:2009 C:2010....)

C: Month(A:01 B:02 C:03 D:04 E:05 F:06 G:07 H:08 I:09 J:10 K:11 L:12)

DEFG: Serial No.

Outline Drawing

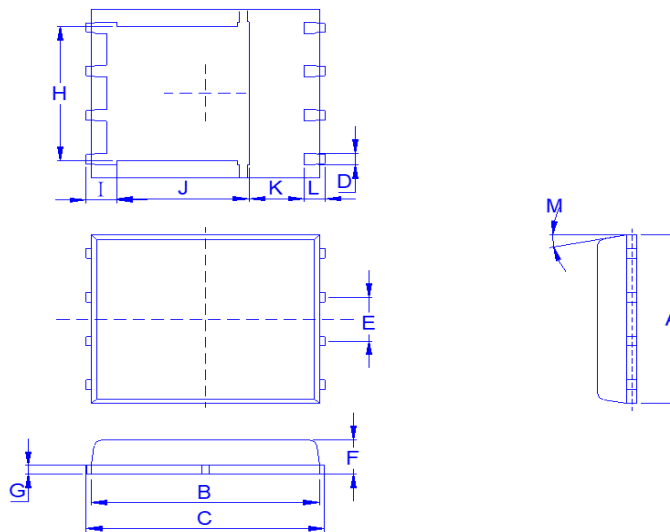

Dimension	A	B	C	D	E	F	G	H	I	J	K	L	M
Min.	4.8	5.55	5.9	0.3	1.17	0.85	0.15	3.61	0.38	3.18	1	0.38	0°
Typ.	4.9	5.7	6	0.4	1.27	0.95	0.2	3.87	0.4	3.44	1.2	0.4	
Max.	5.4	5.85	6.15	0.51	1.37	1.17	0.34	4.31	0.71	3.78	1.39	0.71	12°

Footprint

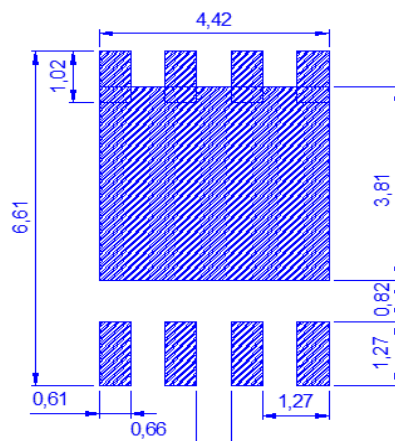

◆ **Tape&Reel Information:2500pcs/Reel**
 (Dimension in millimeter)

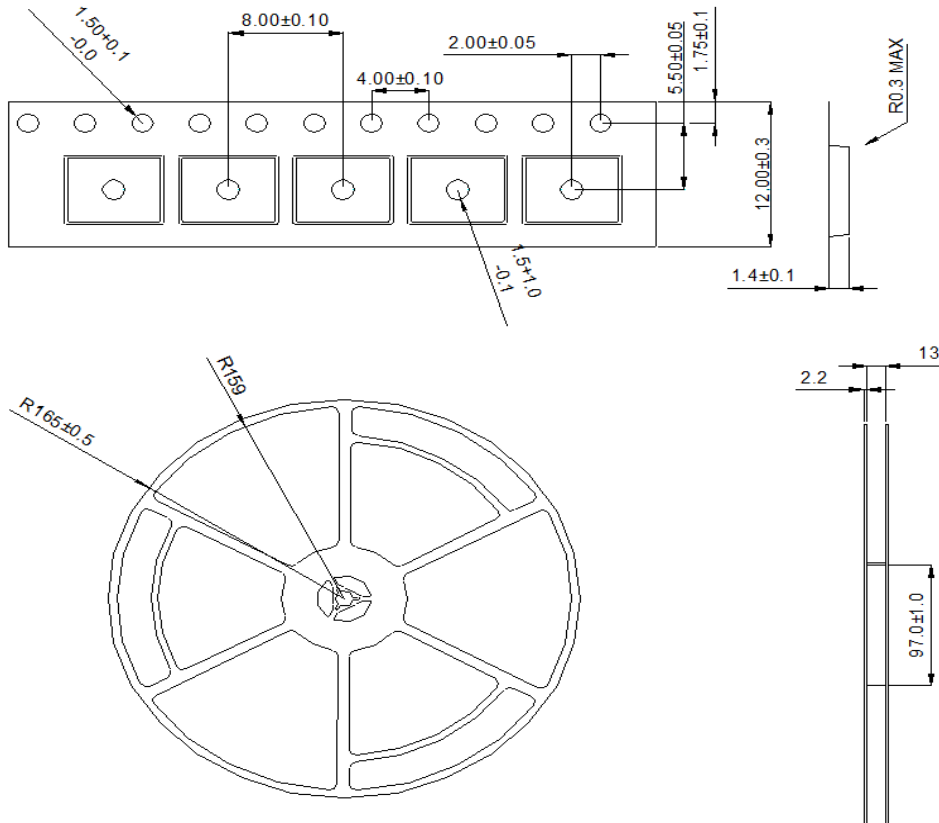

產品別	EDFN 5x6
Reel尺寸	13"
編帶方式	FEED DIRECTION
前空格	25
後空格	50
裝箱數	
滿捲數量	2.5K
捲/內盒比	01:01
內盒滿箱數	2.5K
內/外箱比	10:01
外箱滿箱數	25K



★Datasheet Latest version specification :

	Revision History	Prepared	Approved	Date
A.0	Initial Datasheet	Johnson	Sam	2020/9/2