

300mA, High PSRR, Low Noise LDO Regulator

General Description

The EM1103 performs ultra low drop voltage, high power supply rejection ratio (PSRR), fast response, low noise linear regulator, and designed to continuously deliver up to 300mA output current.

The EM1103 offers a range of 1.5V to 4.5V fixed output, and high output accuracy to 2%.

No by-pass capacitor is needed for this device and only 1uF ceramic capacitor is required for stability in any loading conditions. It reduces the amount of board space necessary for power applications.

The other features include soft start, current limit protection, Power-On-Reset function, and over temperature protection. The EM1103 is available in SOT-23-5 package.

Ordering Information

Part Number	Package	XXX : output Voltage	Remark
EM1103J-XXX	SOT-23-5L	150 : 1.5V 160 : 1.6V : : 450 : 4.5V 185 : 1.85V 285 : 2.85V	

Features

- Ultra Fast Response in Line/Load Transient
- Wide V_{IN} Range from 2.5V to 5.5V
- Custom Voltage Available
- Ultra Low Dropout Voltage: 200mV @300mA
- High Power Supply Rejection Ratio
 - 70dB at 1kHz
 - 55dB at 10kHz
- Ultra Low Output Noise Voltage 100uV_(RMS)
- Low Shutdown Current < 1uA
- Only 1uF Ceramic Capacitor required for stability
- Over Temperature Protection
- Current Limit Protection
- RoHS Compliant and 100% Lead (Pb)-Free

Applications



- Cellular Handsets
- Battery-Powered Equipment
- Laptop, Palmtops, Notebook Computers
- Hand-Held Instruments
- PCMCIA Cards
- Portable Information Applications

Pin Configuration

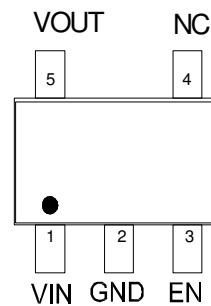

Typical Application Circuit

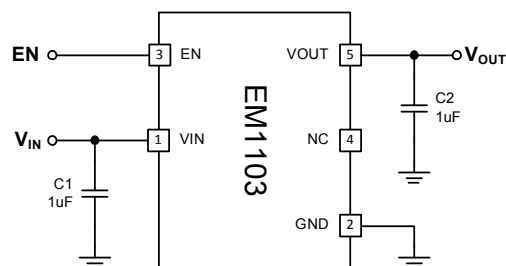

Pin Assignment

Pin Name	Pin No.	Pin Function
VIN	1	Input Voltage. This is the source input to the power device that supplies current to the output pin.
GND	2	Ground.
EN	3	Chip Enable Input (Active high).
NC	4	No Connection.
VOUT	5	Output Voltage. VOUT is power output pin. An internal pull low resistance exists when the device is disabled. Minimum 1uF low ESR ceramic capacitor is required at this pin for stabilizing VOUT voltage.

Function Block Diagram

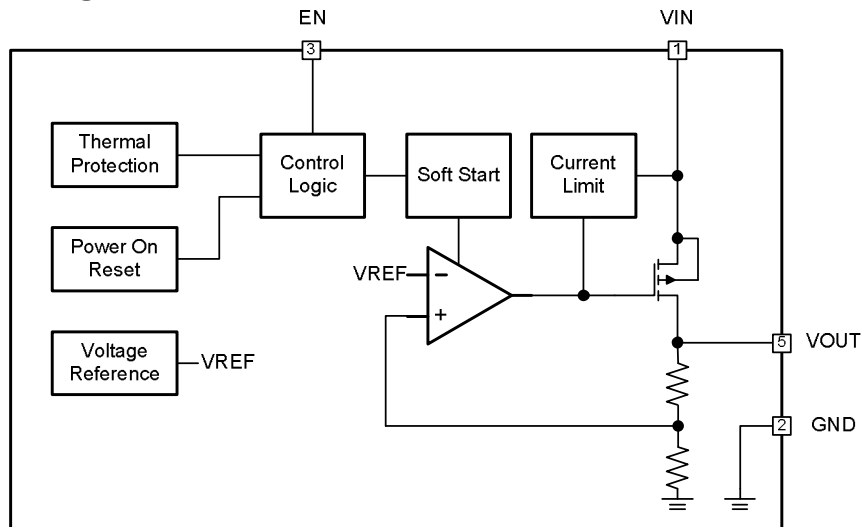

Absolute Maximum Ratings (Note1)

- V_{IN} ----- -0.3V to +6.0V
- Other Pins----- -0.3V to ($V_{IN}+0.3V$)
- Power Dissipation, $P_D @ T_A = 25^\circ C$, SOT23-5 ----- 0.4W
- Package Thermal Resistance, θ_{JA} , SOT23-5 (Note 2)----- 250°C/W
- Junction Temperature----- 150°C
- Lead Temperature (Soldering, 10 sec.)----- 260°C
- Storage Temperature ----- -65°C to 150°C
- ESD susceptibility (Note3)
 - HBM (Human Body Mode)----- 2KV
 - MM (Machine Mode)----- 200V

Recommended Operating Conditions (Note4)

- Supply Input Voltage, V_{IN} ----- +2.5V to +5.5V
- Junction Temperature ----- -40°C to 125°C
- Ambient Temperature ----- -40°C to 85°C

Electrical Characteristics

$V_{IN} = V_{OUT} + 1V$, $T_A = 25^\circ C$, unless otherwise specified

Parameter	Symbol	Test Conditions	Min	Typ	Max	Units
Supply Input Section						
Power Input Voltage	V_{IN}		2.5	-	5.5	V
POR Threshold	V_{PORTH}		-	2.1	2.49	V
POR Hysteresis	V_{PORHYS}		-	0.2	-	V
Quiescent Current	I_Q	$V_{EN} = V_{IN}$, $I_{OUT} = 0A$	-	90	130	μA
Shutdown Current	I_{SD}	$V_{EN} = 0V$	-	0.1	1	μA
Output Voltage						
Output Voltage Accuracy	V_{OUT}	$I_{OUT} = 1mA$	-2	-	2	%
Line Regulation	$V_{OUT(LINE)}$	$V_{OUT} + 1V < V_{IN} < 5.0V$, $I_{OUT} = 1mA$	-	-	0.3	%
Load Regulation	$V_{OUT(LOAD)}$	$1mA < I_{OUT} < 300mA$	-	-	0.6	%
Output Voltage Noise		10Hz to 100kHz, $C_{OUT} = 1\mu F$	-	100	-	$\mu V_{(RMS)}$
Power Supply Rejection Ratio	PSRR	$I_{OUT} = 10mA$, 1kHz	-	70	-	dB
		$I_{OUT} = 10mA$, 10kHz	-	55	-	
		$I_{OUT} = 10mA$, 100kHz	-	40	-	
Dropout Voltage	V_{DROP}	$I_{OUT} = 300mA$ (Note5)	-	200	300	mV
Enable						
Enable High Level	V_{EN}		1.4	-	-	V
Disable Low Level	V_{SD}		-	-	0.38	V
Enable Input Current	I_{EN}	$V_{EN} = 5V$ or $0V$	-1	0	1	μA
Output Voltage Ramp Up Time			-	150	-	μs
Over Current Protection						
OCP Threshold Level	I_{OCP}		360	600	-	mA
Thermal Protection						
Thermal Shutdown Temperature	T_{SD}	$V_{EN} = V_{IN}$, $I_{OUT} = 0A$	-	160	-	$^\circ C$
Thermal Shutdown Hysteresis	T_{SDHYS}	$V_{EN} = V_{IN}$, $I_{OUT} = 0A$	-	30	-	$^\circ C$

Note 1. Stresses listed as the above "Absolute Maximum Ratings" may cause permanent damage to the device. These are for stress ratings. Functional operation of the device at these or any other conditions beyond those indicated in the operational sections of the specifications is not implied. Exposure to absolute maximum rating conditions for extended periods may remain possibility to affect device reliability.

Note 2. θ_{JA} is measured in the natural convection at $T_A = 25^\circ C$ on a low effective thermal conductivity test board of JEDEC 51-3 thermal measurement standard.

Note 3. Devices are ESD sensitive. Handling precaution is recommended.

Note 4. The device is not guaranteed to function outside its operating conditions.

Note 5. The dropout voltage is defined as $(V_{IN} - V_{OUT})$, which is measured when V_{OUT} equals to $(V_{OUT,NORMAL} - 100mV)$.

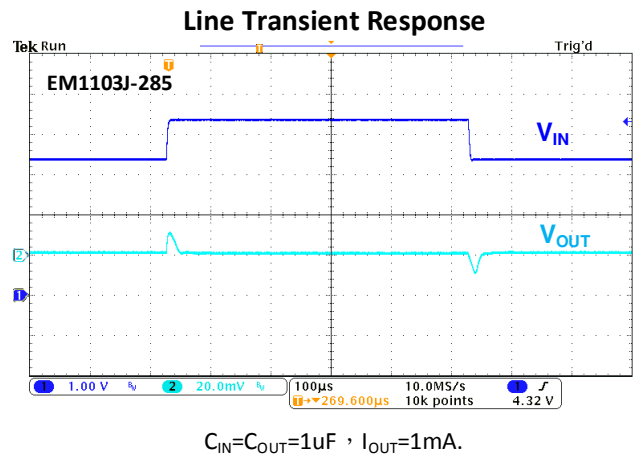
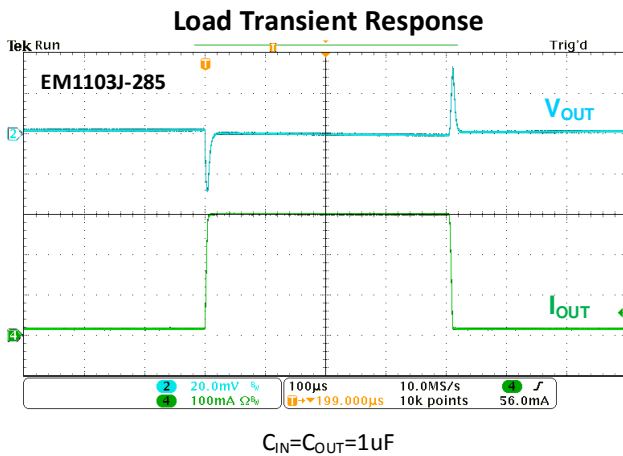
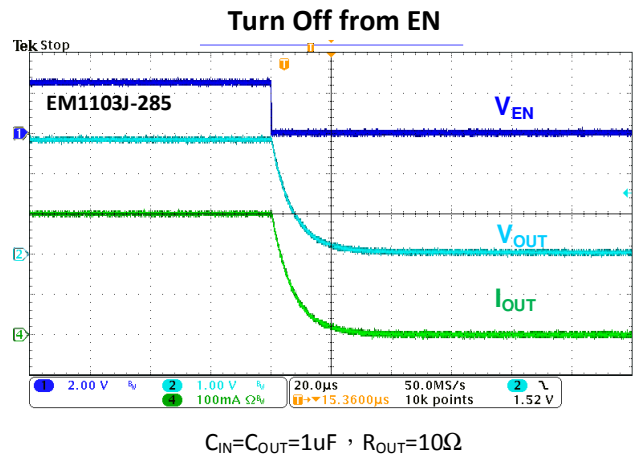
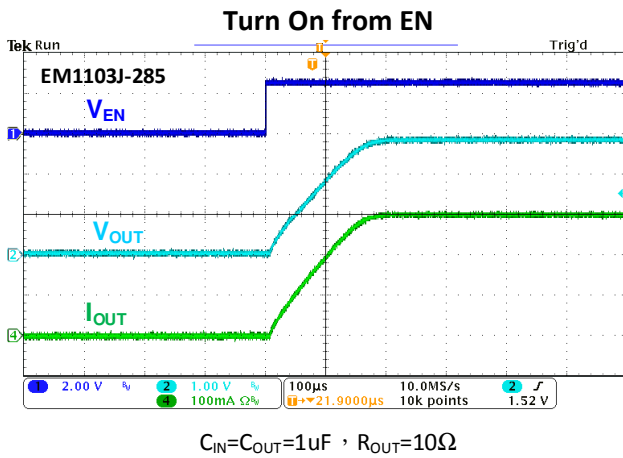
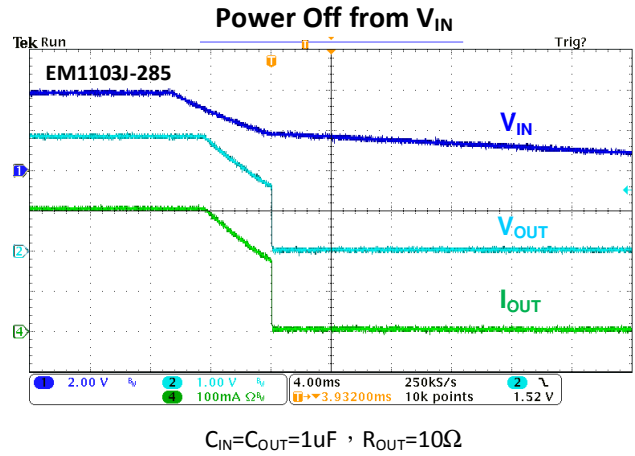
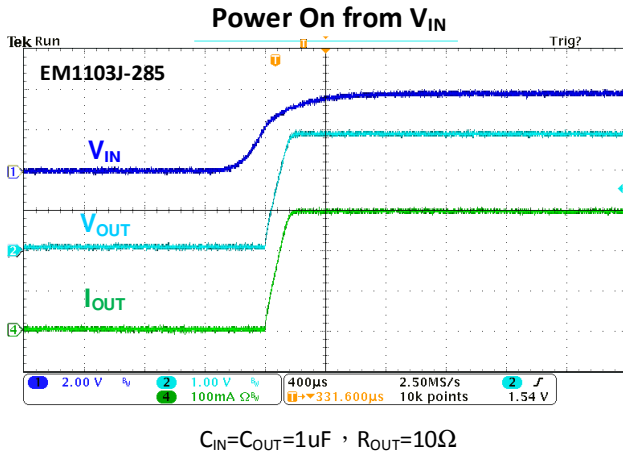

Dropout Voltage v.s. Output Current

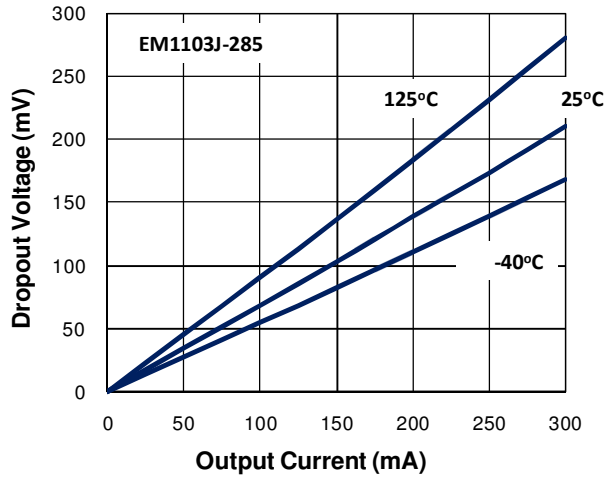

Quiescent Current v.s. Input Voltage

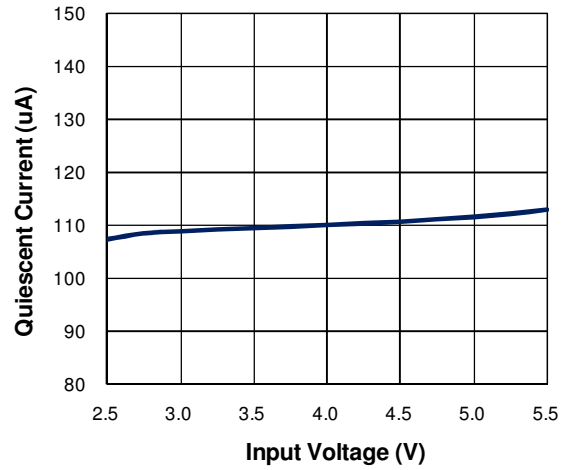

Enable/Disable v.s. Input Voltage

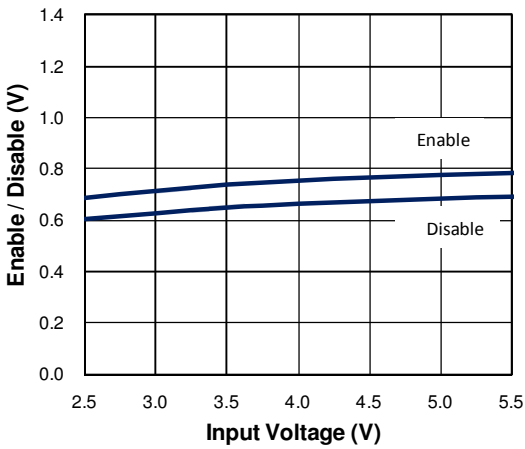

Output Voltage v.s. Input Voltage

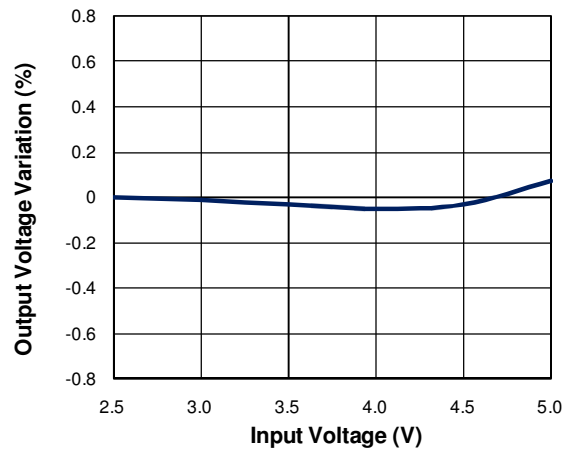

Output Voltage v.s. Temperature

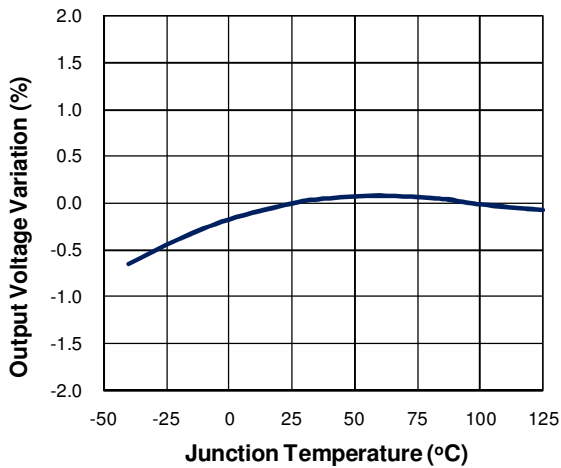

Quiescent Current v.s. Temperature

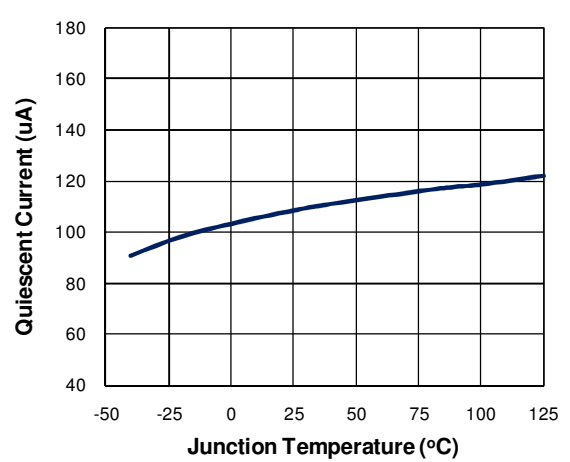

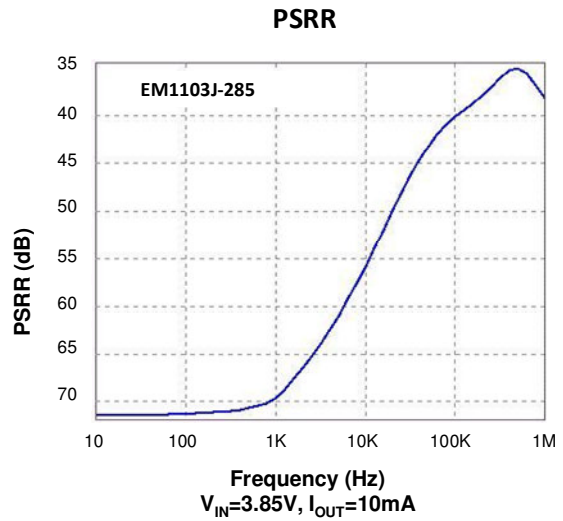
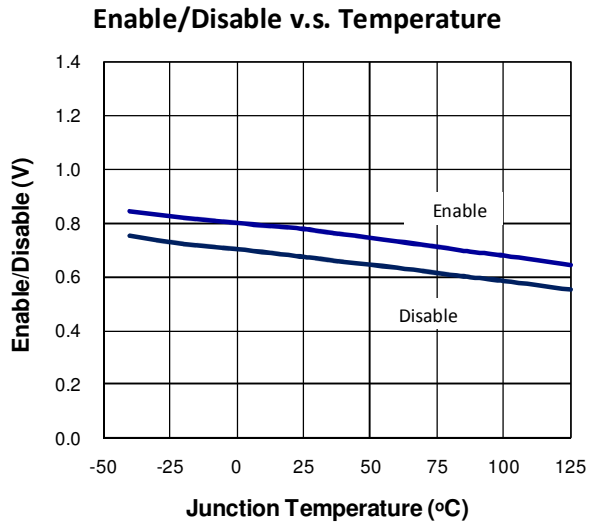
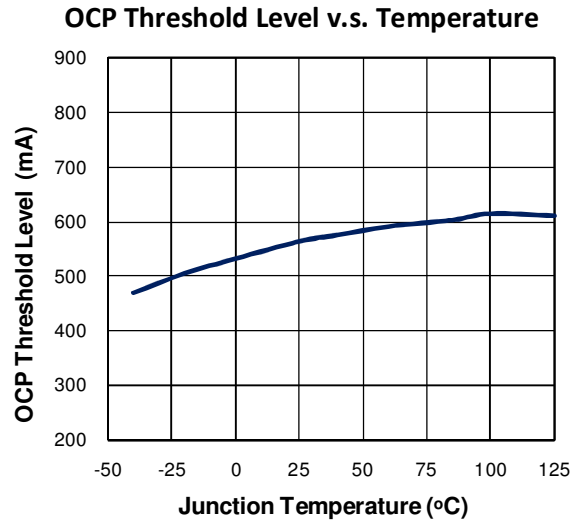
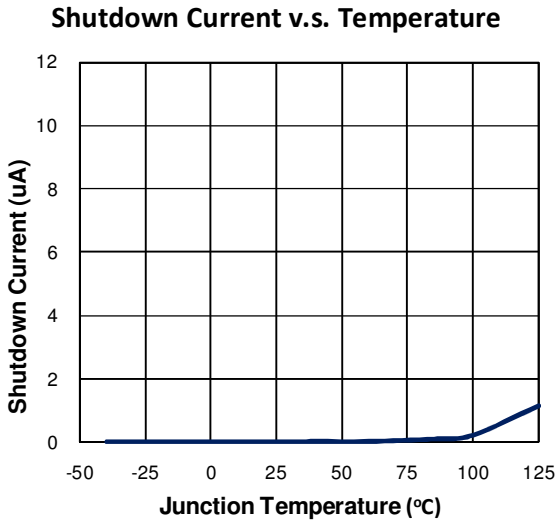

Functional Description

Enable Function

EM1103 is enabled if the voltage of the EN pin is greater than 1.4V. If the voltage of the EN pin is less than 0.38V, the IC will be disabled.

POR – Power ON Reset

To let EM1103 start to operation, input voltage must be higher than its POR voltage even when EN voltage is pulled higher than enable high voltage. Typical POR voltage is 2.1V.

Over Current Limit Function

EM1103 features over current limiting function which can limit its output current to 600mA.

Input and Output Capacitor Selection

For VIN pin, 1uF or larger ceramic capacitor is required to provide bypass path in transient current demand. VOUT pin is also recommended to have 1uF or larger ceramic capacitor to be stable and reduce the VOUT voltage dip when fast loading transient is happened.

Power Dissipation

The maximum power depends on some conditions, including of thermal impedance, PCB layout, airflow, and so on. The maximum power dissipation can be calculated by the formula as below

$$P_{D(max)} = (T_{J(max)} - T_A) / \theta_{JA}$$

$T_{J(max)}$ is the maximum junction temperature; θ_{JA} is the thermal impedance from junction to ambient. The thermal impedance θ_{JA} of SOT23-5 is package design and PCB design dependent.

For recommended specification of EM1103, the maximum junction temperature is 125°C. The θ_{JA} of SOT23-5 is 250°C/W on the standard JEDEC 51-3 thermal test board. The maximum power dissipation (at 25°C ambient) can be calculated as below:

$$P_{D(max \text{ at } 25^\circ\text{C})} = (125^\circ\text{C} - 25^\circ\text{C}) / (250^\circ\text{C}/\text{W}) = 0.4\text{W}$$

Marking Information

Device Name: EM1103J for SOT-23-5

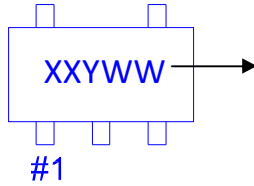

XX: Device Code

output Voltage	Code	output Voltage	Code	output Voltage	Code	output Voltage	Code
1.5	V6	2.0	VA	3.0	VM	4.0	R0
1.6	R6	2.1	VB	3.1	VN	4.1	R1
1.7	R7	2.2	VC	3.2	VP	4.2	R2
1.8	R8	2.3	VD	3.3	VS	4.3	R3
1.9	R9	2.4	VE	3.4	VT	4.4	R4
		2.5	VF	3.5	VU	4.5	V8
		2.6	VG	3.6	VX	1.85	V9
		2.7	VH	3.7	VY	2.85	V7
		2.8	VK	3.8	VZ		
		2.9	VL	3.9			

YWW: Date Code

Outline Drawing

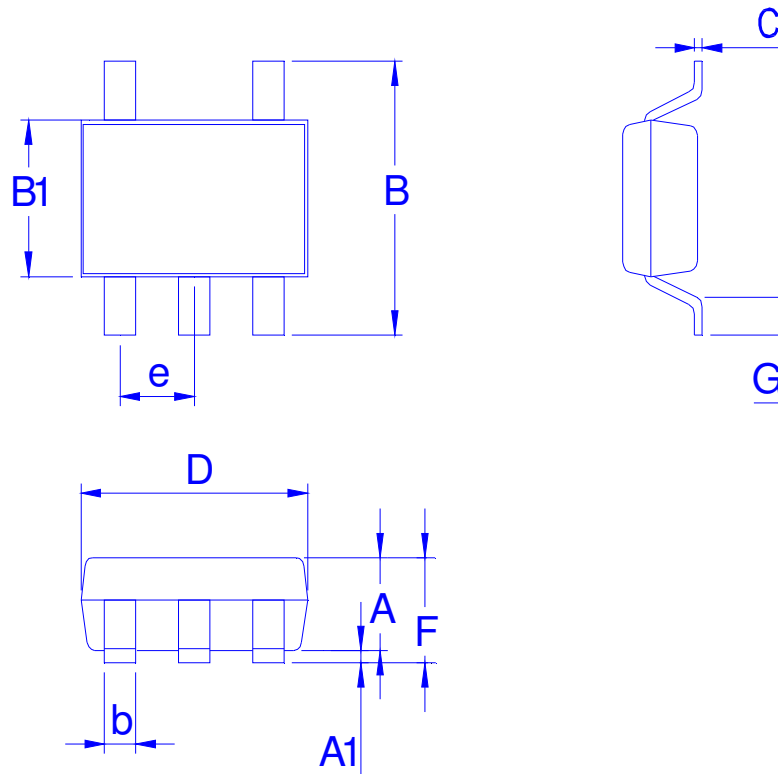

Dimension in mm

Dimension	A	A1	B	B1	b	C	D	e	F	G
Min.	0.90	0.00			0.30	0.08				0.30
Typ.	1.15		2.80	1.60			2.90	0.95		0.45
Max.	1.30	0.15			0.50	0.22			1.45	0.60